

Neosys Technology Inc.

Nuvo-5501 Series

User Manual

Revision 1.1

Table of Contents

Table of Contents	2
Legal Information	4
Contact Information	5
Declaration of Conformity	5
Copyright Notice	6
Safety Precautions	7
Service and Maintenance	8
ESD Precautions	8
About This Manual	9
1 Introduction	
1.1 Product Specifications.....	11
1.1.1 Nuvo-5501	11
1.1.2 Nuvo-5501-DIO.....	13
1.2 Dimension	15
1.2.1 Top View of Nuvo-5501 Series.....	15
1.2.2 Front View of Nuvo-5501 Series	15
1.2.3 Back View of Nuvo-5501 Series.....	16
1.2.4 Side View of Nuvo-5501 Series	16
2 System Overview	
2.1 Nuvo-5501 Packing List	17
2.2 Front Panel I/O	18
2.2.1 Power Button	19
2.2.2 Reset Button	19
2.2.3 USB 2.0 Ports	20
2.2.4 Gigabit Ethernet	21
2.2.5 VGA Port.....	22
2.2.6 DVI-D Port	23
2.2.7 System Status LED Indicators	24
2.2.8 USB3.0 Port.....	24
2.2.9 COM Port.....	25
2.2.10 3-Pin Terminal Block for DC Input	26
2.3 Rear Panel DIO Port (Nuvo-5501-DIO Only)	27
2.4 Internal I/O Functions.....	28
2.4.1 Status LED Output & Remote On/ Off Control	28
2.4.2 Single DRAM SO-DIMM Slot	30
2.4.3 mSATA Slot	30
2.4.4 mini-PCIe Slot.....	32
2.4.5 M.2 2242 and SIM Card Slot.....	34
2.4.6 SATA Port.....	36
2.4.7 Internal USB Port.....	37
3 System Installation	
3.1 Disassembling the System	39
3.2 CPU Installation	41
3.3 DDR4 SO-DIMM Installation.....	45
3.4 Installing M.2 Module	46
3.5 Installing mini-PCIe Module.....	50
3.6 Installing 2.5" HDD/ SSD or 3.5" HDD to SATA Port	53
3.6.1 Installing 2.5" HDD/ SSD (Post 2019)	53
3.6.2 Installing 2.5" HDD/ SSD (Pre 2019).....	55
3.6.3 Installing 3.5" HDD (Post 2019)	57
3.6.4 Installing 3.5" HDD (Pre 2019).....	59
3.7 Installing the System Enclosure	61

3.8	Mounting Nuvo-5501 Series	64
3.8.1	Installing Wall-Mounting Bracket	64
3.8.2	Installing DIN-Rail Mounting Kit (Optional).....	66
4	BIOS Settings	
4.1	COM1 & COM2 Configuration.....	68
4.2	Power On After Power Failure Option.....	70
4.3	Power & Performance (CPU SKU Power Configuration).....	71
4.4	Wake on LAN Option	72
4.5	Boot Menu.....	73
4.5.1	Boot Type (Legacy/ UEFI).....	74
4.5.2	Add Boot Options.....	75
4.5.3	Watchdog Timer for Booting.....	76
4.5.4	Legacy/ UEFI Boot Device.....	77
5	OS Support and Driver Installation	
5.1	Operating System Compatibility	78
5.2	xHCI Driver Support in Microsoft OS.....	79
5.3	User Provided Items for Windows 7 Installation.....	79
5.4	Create Windows 7 USB Installation Flash Drive and Patching xHCI Driver	80
5.4.1	Step1 – Create .ISO File from Windows 7 DVD.....	80
5.4.2	Step 2 – Create USB Flash Drive Installer from .ISO.....	81
5.4.3	Step 3 – Create Folder and Copy Files for Patching Process.....	83
5.4.4	Step 4 – Execute .bat File to Patch .wim Files.....	84
5.4.5	Step 5 – Install Windows 7 Using USB Flash Drive Installer.....	86
5.5	Install Drivers Automatically	87
5.6	Install Drivers Manually	88
5.6.1	Windows 7 (x86)	88
5.6.2	Windows 7 (x64)	88
5.6.3	Windows 8/ 8.1/ 10 (x64)	88
5.7	Driver Installation for Watchdog Timer Control.....	89
5.7.1	Windows 7 (x86)	89
5.7.2	Windows 7/ 8/ 10 (x64)	89
5.7.3	Windows 7/ 8/ 10 (WOW64).....	89
	Appendix A Using WDT & DIO	
	Watchdog Timer	90
	Isolated DIO (Nuvo-5501-DIO Only)	90
	Installing WDT_DIO Library.....	90
	WDT Functions.....	93
	InitWDT	93
	SetWDT	93
	StartWDT	94
	ResetWDT	94
	StopWDT	94
	DIO Functions.....	95
	InitDIO.....	95
	DIReadLine	95
	DIReadPort	95
	DOWriteLine.....	96
	DOWritePort.....	96

Legal Information

All Neosys Technology Inc. products shall be subject to the latest Standard Warranty Policy

Neosys Technology Inc. may modify, update or upgrade the software, firmware or any accompanying user documentation without any prior notice. Neosys Technology Inc. will provide access to these new software, firmware or documentation releases from download sections of our website or through our service partners.

Before installing any software, applications or components provided by a third party, customer should ensure that they are compatible and interoperable with Neosys Technology Inc. product by checking in advance with Neosys Technology Inc.. Customer is solely responsible for ensuring the compatibility and interoperability of the third party's products. Customer is further solely responsible for ensuring its systems, software, and data are adequately backed up as a precaution against possible failures, alternation, or loss.

For questions in regards to hardware/ software compatibility, customers should contact Neosys Technology Inc. sales representative or technical support.

To the extent permitted by applicable laws, Neosys Technology Inc. shall NOT be responsible for any interoperability or compatibility issues that may arise when (1) products, software, or options not certified and supported; (2) configurations not certified and supported are used; (3) parts intended for one system is installed in another system of different make or model.

Contact Information

Headquarters
(Taipei, Taiwan) **Neosys Technology Inc.**
15F, No.868-3, Zhongzheng Rd., Zhonghe Dist., New Taipei City, 23586, Taiwan
Tel: +886-2-2223-6182 Fax: +886-2-2223-6183 [Email](#), [Website](#)

Americas
(Illinois, USA) **Neosys Technology America, Inc.**
3384 Commercial Avenue, Northbrook, IL 60062, USA
Tel: +1-847-656-3298 [Email](#), [Website](#)

China **Neosys Technology China Co., Ltd.**
Room 429 /431, Building 32, Guiping Road 680, Shanghai, 200233, China
Tel: +86-2161155366 [Email](#), [Website](#)

Declaration of Conformity

FCC This equipment has been tested and found to comply with the limits for a Class A digital device, pursuant to part 15 of the FCC Rules. These limits are designed to provide reasonable protection against harmful interference when the equipment is operated in a commercial environment. This equipment generates, uses, and can radiate radio frequency energy and, if not installed and used in accordance with the instruction manual, may cause harmful interference to radio communications. Operation of this equipment in a residential area is likely to cause harmful interference in which case the user will be required to correct the interference at own expense.

CE The product(s) described in this manual complies with all applicable European Union (CE) directives if it has a CE marking. For computer systems to remain CE compliant, only CE-compliant parts may be used. Maintaining CE compliance also requires proper cable and cabling techniques.

Copyright Notice

All rights reserved. This publication may not be reproduced, transmitted, transcribed, stored in a retrieval system, or translated into any language or computer language, in any form or by any means, electronic, mechanical, magnetic, optical, chemical, manual or otherwise, without the prior written consent of Neosys Technology, Inc.

Disclaimer

This manual is intended to be used as an informative guide only and is subject to change without prior notice. It does not represent commitment from Neosys Technology Inc. Neosys Technology Inc. shall not be liable for any direct, indirect, special, incidental, or consequential damages arising from the use of the product or documentation, nor for any infringement on third party rights.

Patents and Trademarks

Neosys, the Neosys logo, Expansion Cassette, MezIO™ are registered patents and trademarks of Neosys Technology, Inc.

Windows is a registered trademark of Microsoft Corporation.

Intel®, Core™ are registered trademarks of Intel Corporation

NVIDIA®, GeForce® are registered trademarks of NVIDIA Corporation

All other names, brands, products or services are trademarks or registered trademarks of their respective owners.

Safety Precautions

- Read these instructions carefully before you install, operate, or transport the system.
- Install the system or DIN rail associated with, at a sturdy location.
- Install the power socket outlet near the system where it is easily accessible.
- Secure each system module(s) using its retaining screws.
- Place power cords and other connection cables away from foot traffic. Do not place items over power cords and make sure they do not rest against data cables.
- Shutdown, disconnect all cables from the system and ground yourself before touching internal modules.
- Ensure that the correct power range is being used before powering the device.
- Should a module fail, arrange for a replacement as soon as possible to minimize down-time.
- If the system is not going to be used for a long time, disconnect it from mains (power socket) to avoid transient over-voltage.

Service and Maintenance

- ONLY qualified personnel should service the system
- Shutdown the system, disconnect the power cord and all other connections before servicing the system
- When replacing/ installing additional components (expansion card, memory module, etc.), insert them as gently as possible while assuring proper connector engagement

ESD Precautions

- Handle add-on module, motherboard by their retention screws or the module's frame/ heat sink. Avoid touching the PCB circuit board or add-on module connector pins
- Use a grounded wrist strap and an anti-static work pad to discharge static electricity when installing or maintaining the system
- Avoid dust, debris, carpets, plastic, vinyl and styrofoam in your work area
- Do not remove any module or component from its anti-static bag before installation

About This Manual

This guide introduces Neousys Nuvo-5501 system. It is a compact fanless embedded controller with Intel® 6th-Gen Core™ i7/ i5/ i3 processor.

The guide also demonstrates the system's basic installation procedures.

Revision History

Version	Date	Description
1.0	Apr. 2018	Initial release
1.1	May. 2019	Updated system power consumption Added type-2 HDD/ SSD bracket installation procedure

1 Introduction

Nuvo-5501 series features compact fanless embedded controllers for the cost and space conscious. Based on Intel® Skylake platform, it is designed to provide cutting-edge performance and reliable operation in extreme environment. Its LGA 1151 socket offers users the flexibility to select a 35W CPU from 6th-Gen Intel® Core™ i to Celeron® lineup to suit application needs.

Nuvo-5501 is the most compact fanless embedded controller supporting Skylake LGA 1151 socket CPUs, measuring just 221 x 173 x 76 mm, it is easy to deploy in restricted spaces. In its compact

enclosure, Nuvo-5501 features rich, front-accessible I/Os including 3x GbE, 4x USB 3.0 and 4x COM ports.



There is even enough room for a 3.5”

HDD compatible with the latest storage capacities.

The compact Nuvo-5501 is a cost-effective solution that does not compromise on performance and reliability, making it the ideal embedded controller for various industrial applications.

1.1 Product Specifications

1.1.1 Nuvo-5501

System Core	
Processor	Supports following CPUs Intel® Core™ i7-6700TE (8M Cache, 2.4/ 3.4 GHz, 35W TDP) Intel® Core™ i5-6500TE (6M Cache, 2.3/ 3.3 GHz, 35W TDP) Intel® Core™ i3-6100TE (4M Cache, 2.7 GHz, 35W TDP) Intel® Pentium® G4400TE (3M Cache, 2.4 GHz, 35W TDP) Intel® Celeron® G3900TE (2M Cache, 2.3 GHz, 35W TDP)
Chipset	Intel® H110 platform controller hub
Graphics	Integrated Intel® HD 530/ 510 controller
Memory	Up to 16GB DDR4-2133 (single SO-DIMM)
I/O Interface	
Ethernet port	1x Gigabit Ethernet port (via Intel I219-LM) 2x Gigabit Ethernet port (via Intel I210-IT)
USB	4x USB3.0 ports 2x USB2.0 ports
Video Port	1x VGA connector 1x DVI-D connector
Serial Port	2x software-programmable RS-232/ 422/ 485 ports 2x RS-232 ports
Storage Interface	
SATA HDD	1x internal SATA port for 3.5" HDD or 2.5" HDD/ SSD
mSATA	1x full-size mSATA socket
Expansion Bus/ Internal I/O Interface	
mini-PCIe	1x full-size mini PCI Express socket
M.2	1x M.2 B key socket for 3G/4G options with SIM socket
USB	1x internal USB2.0 port
Remote Ctrl. & Status Output	1x 2x6-pin 2.0mm pin-header connector for remote on/off control and status LED output
Power Supply	
DC Input	1x 3-pin pluggable terminal block for 8~35 VDC power input
Max Power Consumption	With Core™ i7-6700TE: 47.3W (@24V) With Core™ i5-6500TE: 46.8W (@24V) With Core™ i3-6100TE: 42.5W (@24V)

Mechanical	
Dimension	221 mm (W) x 173 mm (D) x 76.2 mm (H)
Weight	2.8 kg (incl. CPU, memory and HDD)
Mounting	Wall-mount (standard) or DIN-rail mount (optional)
Environmental	
Temperature	Storage: -40°C ~ 85°C Operating: -25°C ~ 70°C**
Humidity	10%~90% , non-condensing
Vibration	Operating, 5 Grms, 5-500 Hz, 3 Axes (w/ SSD, according to IEC60068-2-64)
Shock	Operating, 50 Grms, half-sine 11 ms duration (w/ SSD, according to IEC60068-2-27)
EMC	CE/FCC Class A, according to EN 55032 & EN 55024

* The 100% CPU loading is applied using Passmark® BurnInTest 8.1. For detail testing criteria, please contact Neosys Technology.

** For sub-zero operating temperature, a wide temperature HDD drive or Solid State Disk (SSD) is required.

1.1.2 Nuvo-5501-DIO

System Core	
Processor	Supports following CPUs Intel® Core™ i7-6700TE (8M Cache, 2.4/ 3.4 GHz, 35W TDP) Intel® Core™ i5-6500TE (6M Cache, 2.3/ 3.3 GHz, 35W TDP) Intel® Core™ i3-6100TE (4M Cache, 2.7 GHz, 35W TDP) Intel® Pentium® G4400TE (3M Cache, 2.4 GHz, 35W TDP) Intel® Celeron® G3900TE (2M Cache, 2.3 GHz, 35W TDP)
Chipset	Intel® H110 platform controller hub
Graphics	Integrated Intel® HD 530/ 510 controller
Memory	Up to 16GB DDR4-2133 (single SO-DIMM)
I/O Interface	
Ethernet port	1x Gigabit Ethernet port (via Intel I219-LM) 2x Gigabit Ethernet port (via Intel I210-IT)
USB	4x USB3.0 ports 2x USB2.0 ports
Video Port	1x VGA connector 1x DVI-D connector
Serial Port	2x software-programmable RS-232/ 422/ 485 ports 2x RS-232 ports
Isolated DIO	8-CH isolated DI and 8-CH isolated DO
Storage Interface	
SATA HDD	1x internal SATA port for 3.5" HDD or 2.5" HDD/ SSD
mSATA	1x full-size mSATA socket
Expansion Bus/ Internal I/O Interface	
mini-PCIe	1x full-size mini PCI Express socket
M.2	1x M.2 B key socket for 3G/4G options with SIM socket
USB	1x internal USB2.0 port
Remote Ctrl. & Status Output	1x 2x6-pin 2.0mm pin-header connector for remote on/off control and status LED output
Power Supply	
DC Input	1x 3-pin pluggable terminal block for 8~35 VDC power input
Max Power Consumption	With Core™ i7-6700TE: 47.3W (@24V) With Core™ i5-6500TE: 46.8W (@24V) With Core™ i3-6100TE: 42.5W (@24V)

Mechanical	
Dimension	221 mm (W) x 173 mm (D) x 76.2 mm (H)
Weight	2.8 kg (incl. CPU, memory and HDD)
Mounting	Wall-mount (standard) or DIN-rail mount (optional)
Environmental	
Temperature	Storage: -40°C ~ 85°C Operating: -25°C ~ 70°C**
Humidity	10%~90% , non-condensing
Vibration	Operating, 5 Grms, 5-500 Hz, 3 Axes (w/ SSD, according to IEC60068-2-64)
Shock	Operating, 50 Grms, half-sine 11 ms duration (w/ SSD, according to IEC60068-2-27)
EMC	CE/FCC Class A, according to EN 55032 & EN 55024

* The 100% CPU loading is applied using Passmark® BurnInTest 8.1. For detail testing criteria, please contact Neosys Technology.

** For sub-zero operating temperature, a wide temperature HDD drive or Solid State Disk (SSD) is required.

1.2 Dimension

1.2.1 Top View of Nuvo-5501 Series

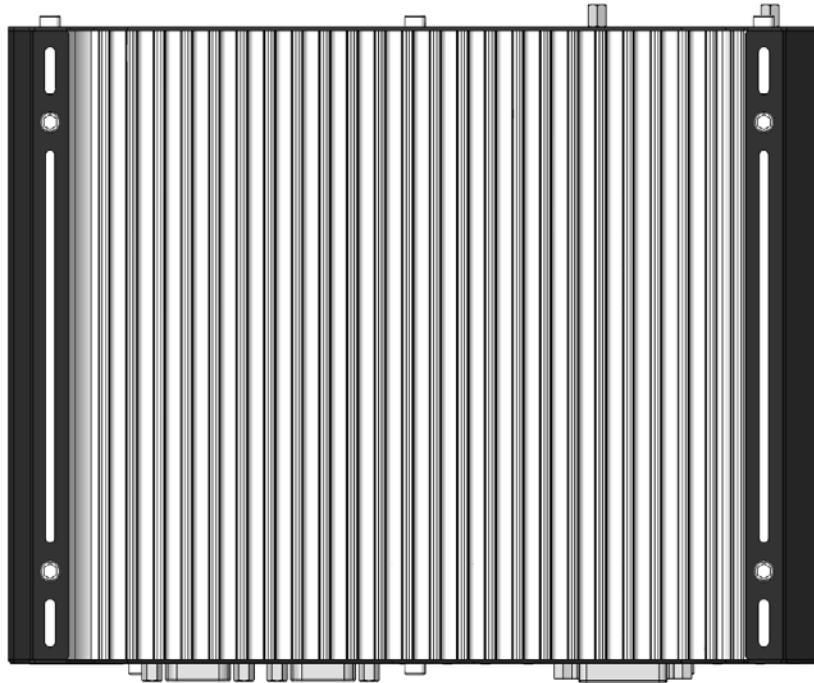

NOTE

All measurements are in millimeters (mm).

1.2.2 Front View of Nuvo-5501 Series

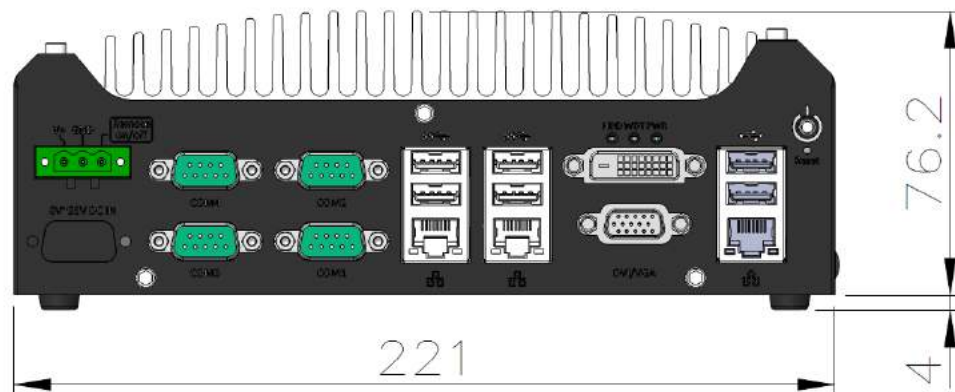

NOTE

All measurements are in millimeters (mm).

1.2.3 Back View of Nuvo-5501 Series

DIO port is applicable to the highlighted area in blue for Nuvo-5501-DIO system.

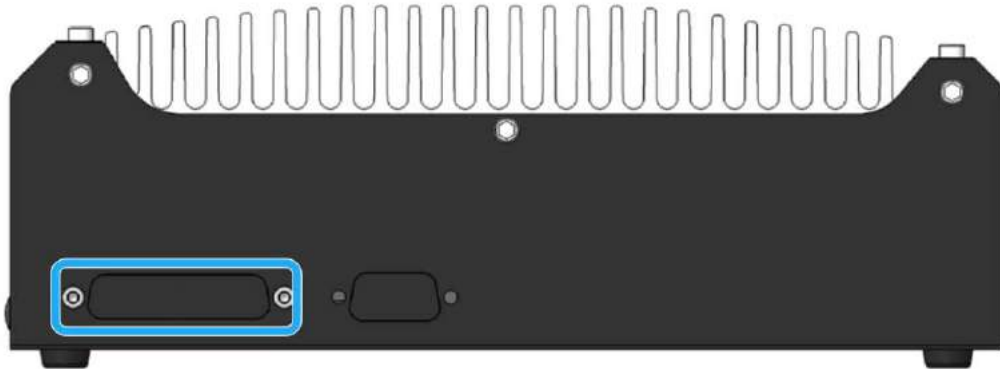

1.2.4 Side View of Nuvo-5501 Series

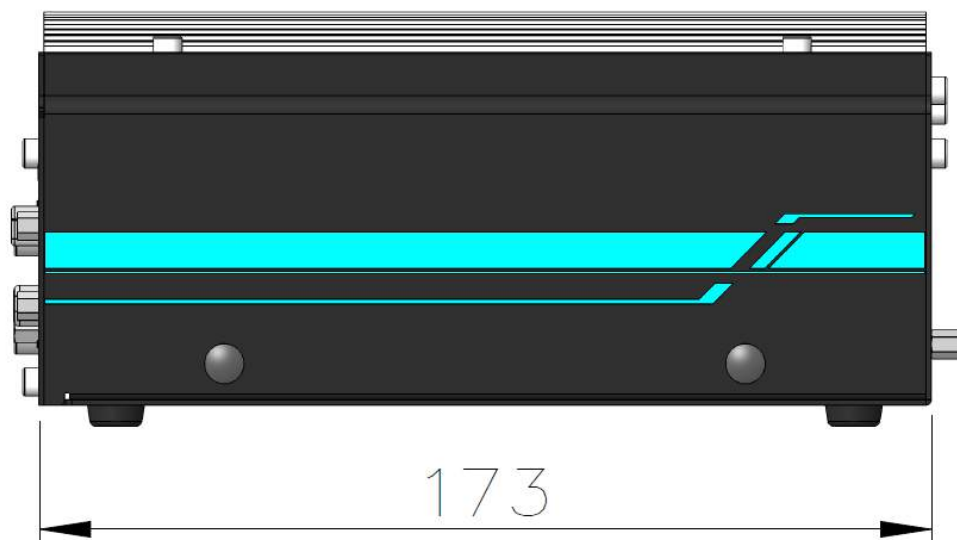

NOTE

All measurements are in millimeters (mm).

2 System Overview

Upon receiving and unpacking your Nuvo-5501, please check immediately if the package contains all the items listed in the following table. If any item(s) are missing or damaged, please contact your local dealer or Neosys Technology.

2.1 Nuvo-5501 Packing List

System Pack	Nuo-5501	Qty
1	Nuvo-5501 (If you ordered CPU/ RAM/ HDD, please verify these items)	1
2	Accessory box, which contains <ul style="list-style-type: none"> ● HDD/SSD bracket ● CPU bracket ● Wall-mounting bracket ● Neosys drivers & utilities DVD ● 3-pin power terminal block ● Screw pack 	1 1 2 1 1 4

2.2 Front Panel I/O

The Nuvo-5501 I/O panel features three gigabit Ethernet ports, four USB3.0 ports, two USB2.0 ports, one VGA connector, one DVI-D connector and four serial ports.

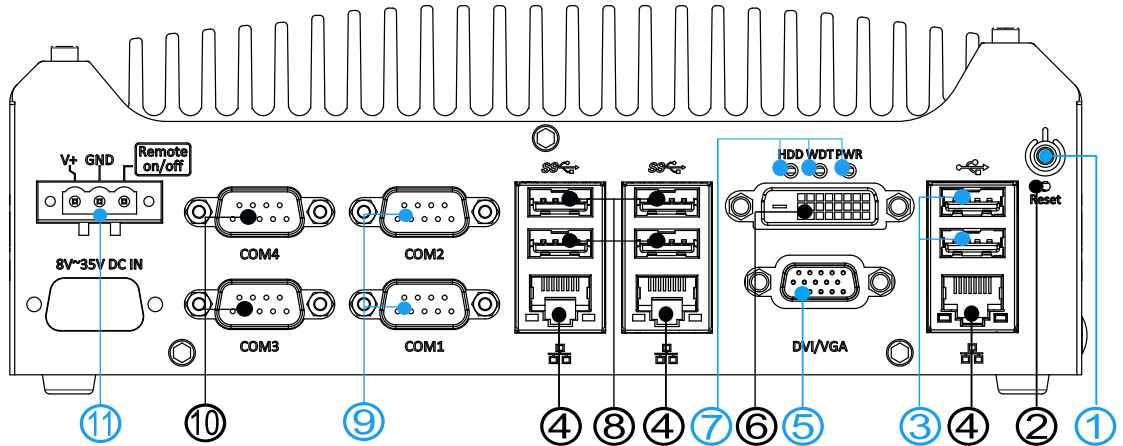

No.	Item	Description
1	Power button	Use this button to turn on or shutdown the system.
2	Reset button	Use this button to manually reset the system.
3	USB 2.0	The USB 2.0 ports are backward with USB 1.1 / 1.0.
4	GbE ports	The Ethernet ports support 10/ 100/ 1000Mbps network connections.
5	VGA port	VGA output supports resolution up to 1920x1200@60Hz.
6	DVI-D port	DVI-D output supports resolution up to 1920x1200@60Hz and is compatible with other digital connections via an adapter.
7	System status LEDs	Three system LEDs, Power (PWR), Watchdog Timer (WDT), and Hard Disk Drive (HDD).
8	USB 3.0 port	USB 3.0 port supports up to 5 Gbit/s data transfer bandwidth.
9	COM port 1 & 2	COM ports 1 & 2 are software-configurable RS-232/422/485 ports
10	COM port 3 & 4	COM3 and COM4 are standard 9-wire RS-232 ports
11	3-pin terminal block (DC/ remote on/ off)	Compatible with DC power input from 8~35V, the terminal block is also used for remote on/ off control.

2.2.1 Power Button

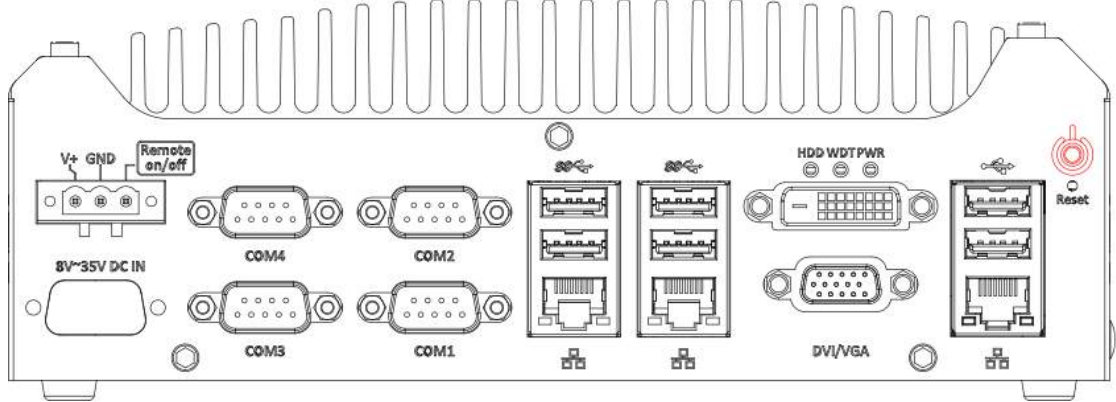

The power button is a non-latched switch for ATX mode on/off operation. Press to turn on the system, PWR LED should light up and to turn off, you can either issue a shutdown command in the OS, or just press the power button. In case of system halts, you can press and hold the power button for 5 seconds to force-shutdown the system. Please note that there is a 5 seconds interval between two on/off operations (i.e. once turning off the system, you will need to wait for 5 seconds to initiate another power-on operation).

2.2.2 Reset Button

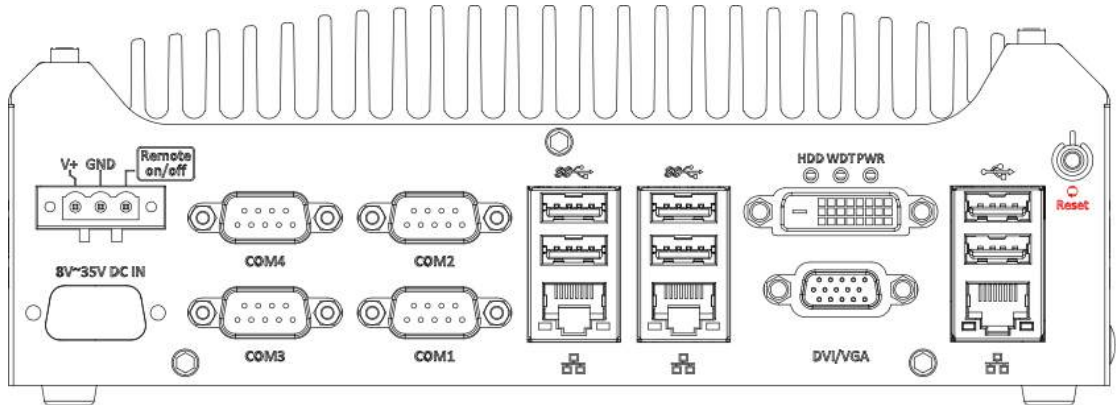

The reset button can be used to manually reset the system in case of abnormal condition. To avoid unexpected operation, the reset button is hidden behind the front panel. You need to use a pin-like object to push the reset button.

2.2.3 USB 2.0 Ports

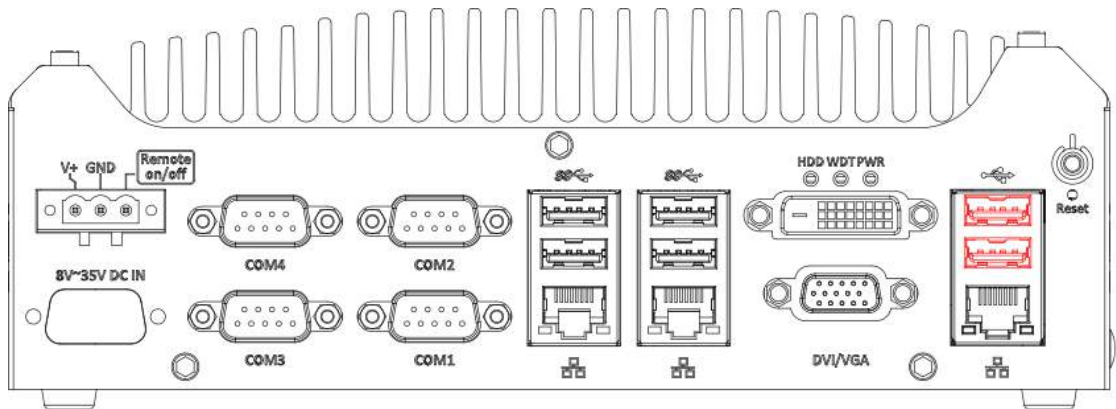

In addition to USB 3.0, Nuvo-5501 Series provides two USB 2.0 ports on the front panel. They are implemented by native xHCI (eXtensible Host Controller Interface) controller in H110 chipset and are compatible with USB 2.0, USB 1.1 and USB 1.0 devices. Legacy USB support is also provided so you can use USB keyboard/mouse in DOS environment.

As the xHCI driver is not included natively in Windows 7, your USB keyboard/ mouse may not work during the installation of Windows 7. Please refer to the section, [Operating System and Driver Installation section](#).

2.2.4 Gigabit Ethernet

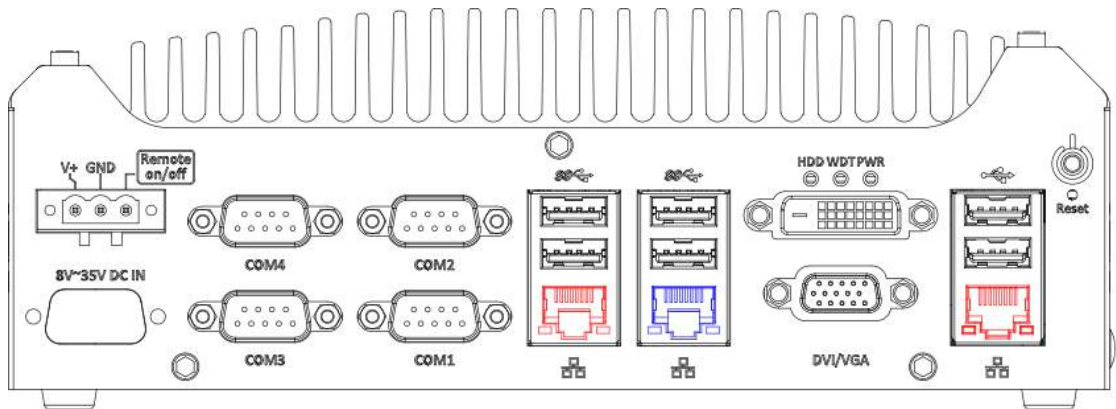

The system offers 3 GbE ports on its I/O panel. The GbE ports are marked in blue/red and are implemented with Intel® I219-LM/ Intel® I210-IT controllers, respectively. Each port has one dedicated PCI Express link for maximum performance. When an Ethernet connection is established, the LED indicators on the RJ45 connector represents the following connection statuses:

Active/Link LED

LED Color	Status	Description
Green	Off	Ethernet port is disconnected
	On	Ethernet port is connected and no data transmission
	Flashing	Ethernet port is connected and data is transmitting/receiving

Speed LED

LED Color	Status	Description
Green or Orange	Off	10 Mbps
	Green	100 Mbps
	Orange	1000 Mbps

The port implemented using Intel® I219-LM (in blue) supports Wake-on-LAN function. Drivers may be required to utilize the GbE port in Windows environment.

2.2.5 VGA Port

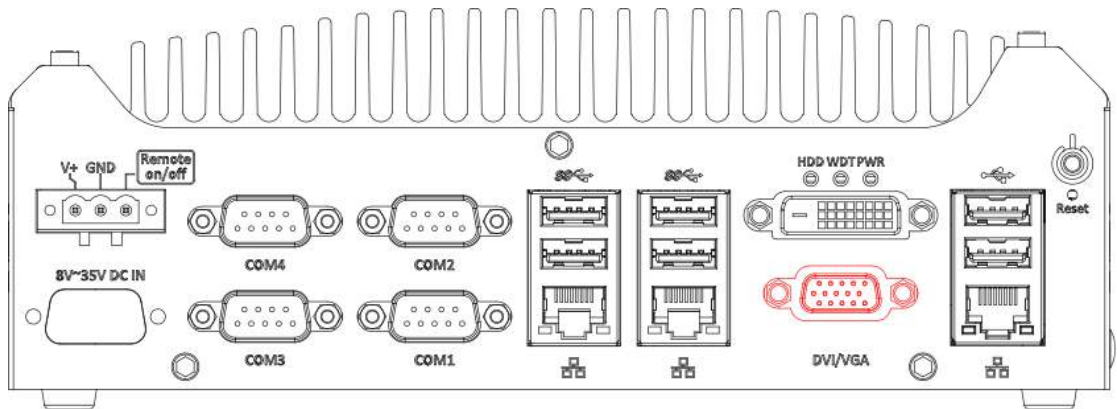

Nuvo-5501 series has dual display outputs on its front panel for connecting different displays according to your system configuration. VGA connector is the most popular way for connecting a display. The VGA output on Nuvo-5501 series supports up to 1920 x 1200 resolution. To support multiple display outputs and achieve best DVI output resolution in Windows, you need to install corresponding graphics driver. Please refer to section 5.5 for information on driver installation.



NOTE

Please make sure your VGA cable includes SDA and SCL (DDC clock and data) signals for correct communication with monitor to get resolution/timing information. A cable without SDA/SCL can cause blank screen on your VGA monitor due to incorrect resolution/timing output.

2.2.6 DVI-D Port

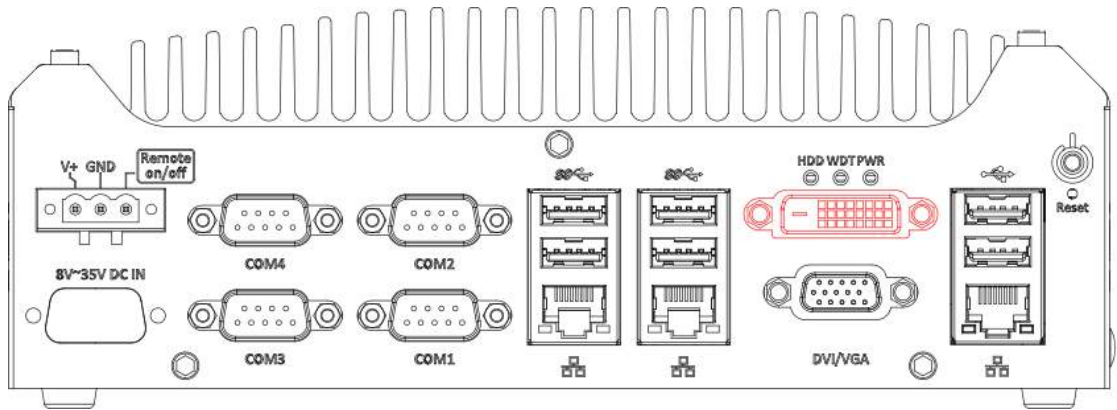

The system has one DVI-D connector on its I/O panel to support independent display output. DVI transmits graphics data in digital format and therefore can deliver better image quality at high resolutions. The DVI connector can output DVI or other digital signals via an adapter or dedicated cable up to 1920 x 1200 resolution.



DVI to HDMI cable



DVI-VGA adapter

2.2.7 System Status LED Indicators

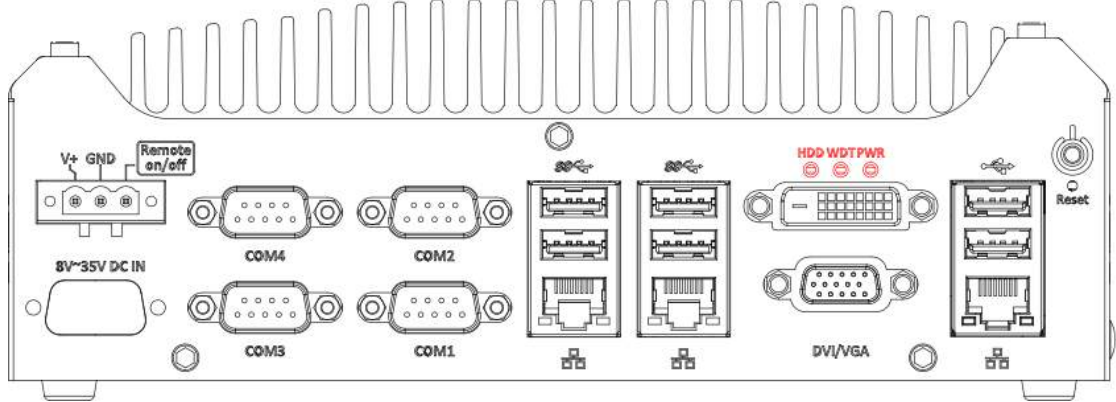

There are three LED indicators on the I/O panel: PWR, WDT and HDD. The descriptions of these three LED are listed in the following table.

Indicator	Color	Description
PWR	Green	Power indicator, lighted-up when system is on.
WDT	Yellow	Watchdog timer LED, flashing when watchdog timer is started.
HDD	Red	Hard drive indicator, flashing when SATA HDD is active.

2.2.8 USB3.0 Port

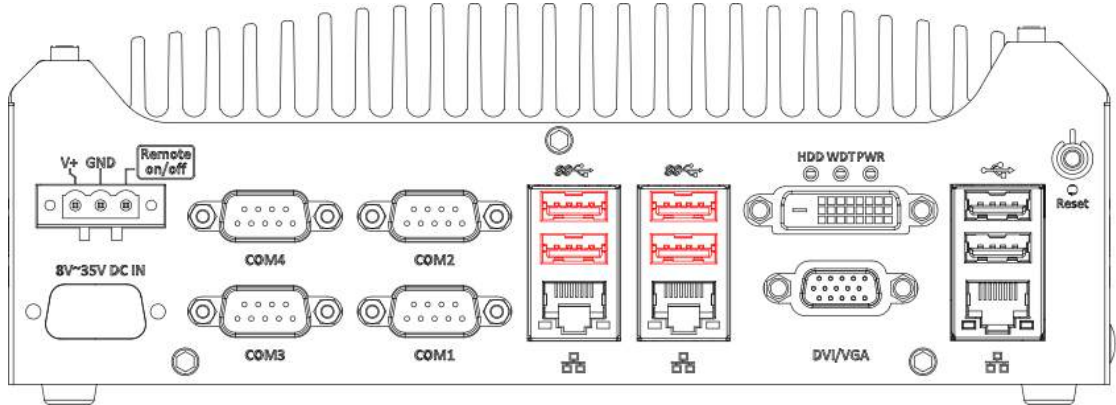

The system offers four USB 3.0 (SuperSpeed USB) ports on its I/O panel. They are implemented by native xHCI (eXtensible Host Controller Interface) controller in H110 chipset and are compatible with USB 3.0, USB 2.0, USB 1.1 and USB 1.0 devices. Legacy USB support is also provided so you can use USB keyboard/mouse in DOS environment.

As the xHCI driver is not included natively in Windows 7, your USB keyboard/ mouse may not work during the installation of Windows 7. Please refer to the section, Operating System and Driver Installation section.

2.2.9 COM Port

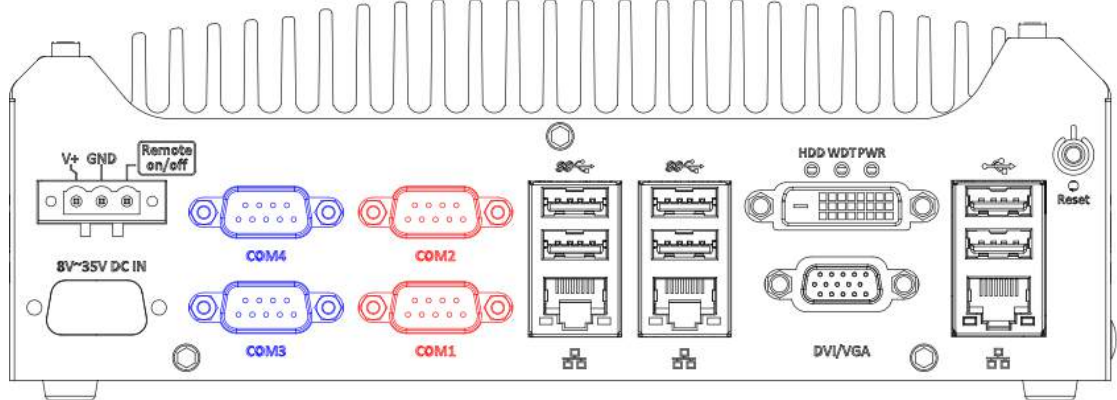

The system provides four COM ports for communicating with external devices. These COM ports are implemented using industrial-grade ITE8786 Super IO chip (-40 to 85°C) and provide up to 115200 bps baud rate.

COM1 and COM2 are software-configurable RS-232/422/485 ports. COM3 and COM4 are standard 9-wire RS-232 ports. The operation mode of COM1 and COM2 can be set in BIOS setup utility. The following table describes the pin definition of COM ports.

COM Port Pin Definition

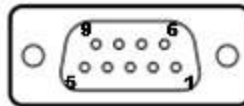

Pin#	COM1 & COM2			COM3 & COM4
	RS-232 Mode	RS-422 Mode	RS-485 Mode (Two-wire 485)	RS-232 Mode
1	DCD			DCD
2	RX	422 TXD+	485 TXD+/RXD+	RX
3	TX	422 RXD+		TX
4	DTR	422 RXD-		DTR
5	GND	GND	GND	GND
6	DSR			DSR
7	RTS			RTS
8	CTS	422 TXD-	485 TXD-/RXD-	CTS
9	RI			RI

2.2.10 3-Pin Terminal Block for DC Input

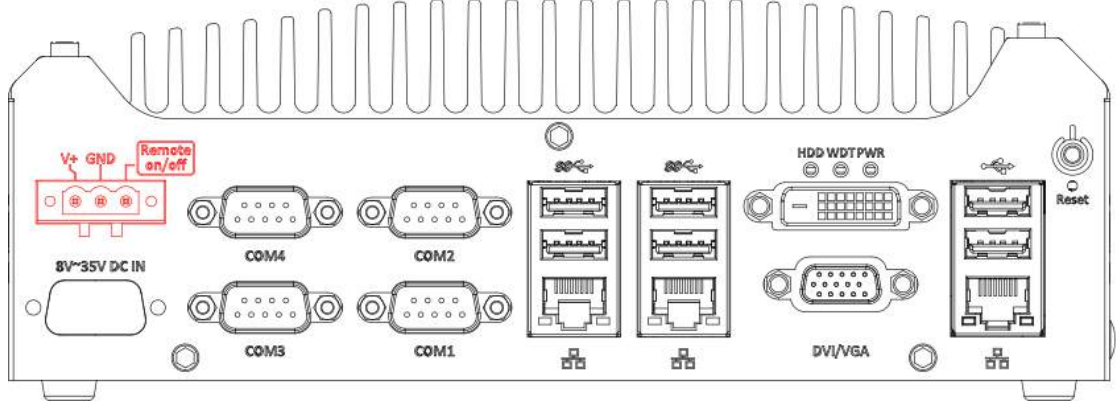

The system allows DC power input from 8 to 35V via a 3-pin pluggable terminal block, which is ideal for field usage where DC power is provided. The screw clamping mechanism of the terminal block offers utmost reliability when wiring DC power.

Symbol	Description
Remote on/off	Connecting to an external switch to turn on/off the system.
GND	Negative polarity (ground) of DC input
V+	Positive polarity of DC input

2.3 Rear Panel DIO Port (Nuvo-5501-DIO Only)

The digital input (DI) and digital output (DO) function provides eight isolated DI and eight isolated DO on the back panel of Nuvo-5501 via DB25 female connector.

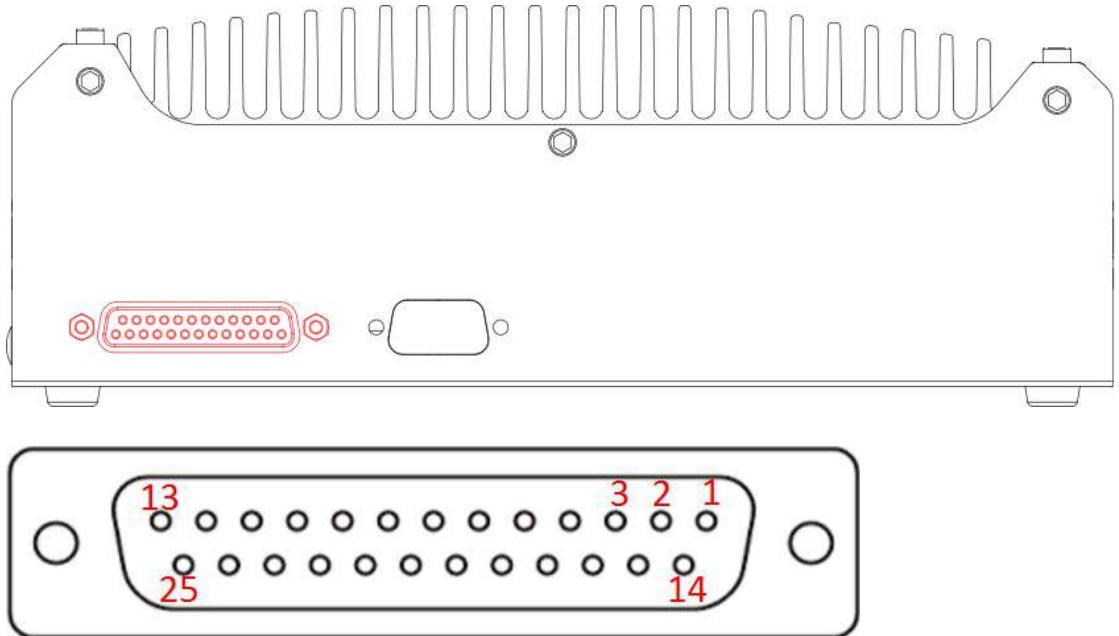

Pin Definition

Pin #	Signal	Pin #	Signal
1	VDD	14	DOGND
2	DO0*	15	DO1 *
3	DO2 *	16	DO3 *
4	DO4	17	DO4GND
5	DO5	18	DO5GND
6	DO6	19	DO6GND
7	DO7	20	DO7GND
8	DIGND	21	D10
9	D14	22	D11
10	D15	23	DIGND
11	DIGND	24	D12
12	D16	25	D13
13	D17		

* When using DO0 ~ DO3, DOGND is the ground should be used.

2.4 Internal I/O Functions

In addition to I/O connectors on the front panel, the system also provides internal on-board connectors, such as remote on/off control, LED status output, internal USB 2.0 ports and etc. In this section, we'll illustrate these internal I/O functions.

2.4.1 Status LED Output & Remote On/ Off Control

For an application which places the system inside a cabinet, it's useful to have an external system status LED indicators. The system provides a 2x6, 2.0mm pitch pin header to output system status such as power, HDD, watchdog timer, and control system on/ off remotely.

The status LED output has a built-in series-resistor and provides 10mA current to directly drive the external LED indicators. System on/ off control is also provided so you can use an external non-latched switch to turn on/ off the system exactly the same as the power button on the front panel. The following table describes the pin definition of the status LED output.

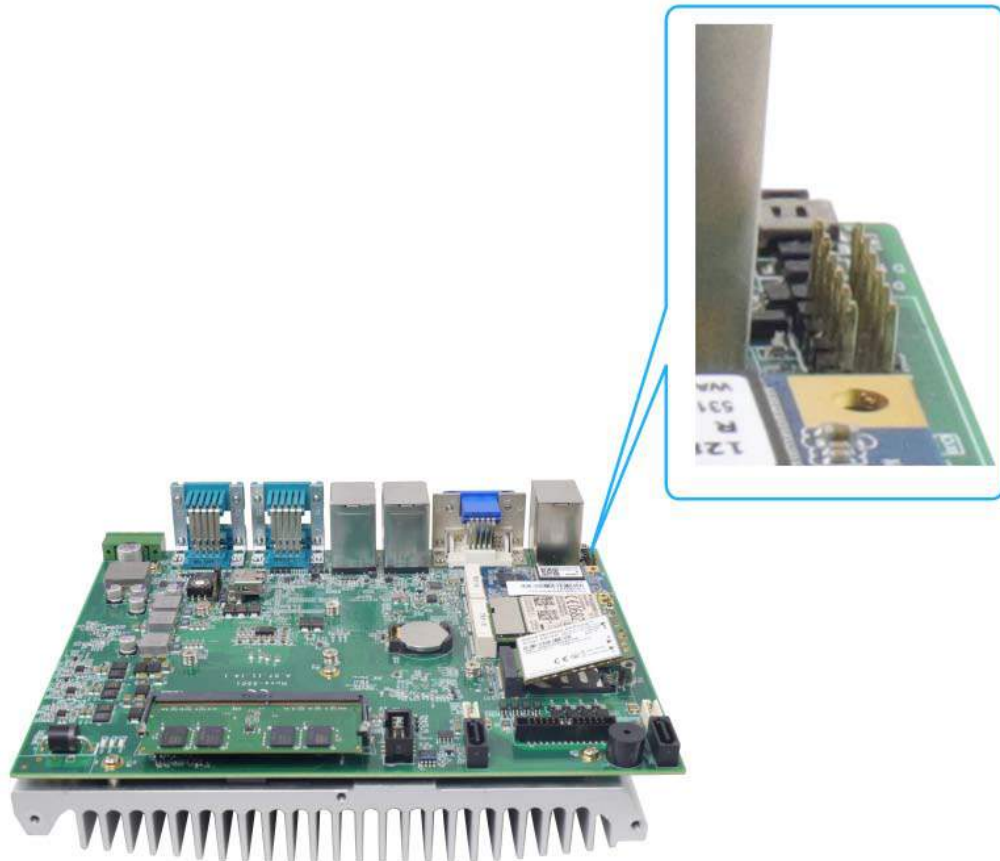

Location of status LED output & remote on/ off control and pin definition

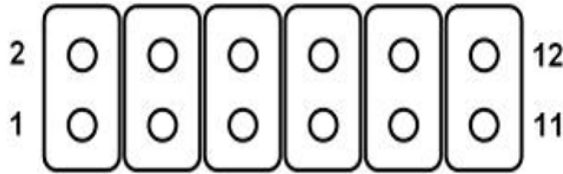

Pin#	Definition	Description
1	WDT_LED-	[Output] Watchdog timer indicator, flashing when watchdog timer is started.
2	WDT_LED+	
3	NA	Un-used pin
4	NA	
5	HDD-	[Output] Hard drive indicator, flashing when SATA hard drive is active.
6	HDD+	
7	Power_LED-	[Output] System power indicator, on if system is turned on, off if system is turned off.
8	Power_LED+	
9	Ctrl-	[Input] Remote on/off control, connecting to an external switch to turn on/off the system. (polarity is negligible).
10	Ctrl+	
11	NA	Un-used pin
12	NA	

 **NOTE**

Please make sure the polarity is correct when you connect the external LED indicator to the Status LED Output.

2.4.2 Single DRAM SO-DIMM Slot



2.4.3 mSATA Slot



Nuvo-5501 provides an mSATA port to accommodate mSATA flash disk module. mSATA is a solid-state disk with all the advantages of solid state disk technology such as lower power consumption and is extremely reliable for harsh environments with intense vibration/shock.

mSATA Socket Definition

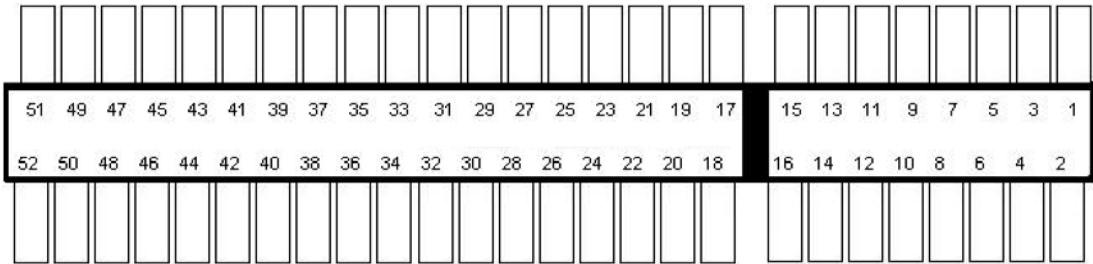

Pin #	Signal (mSATA)	Pin #	Signal (mSATA)
1	-	2	+3.3Vaux
3	-	4	GND
5	-	6	+1.5V
7	-	8	-
9	GND	10	-
11	-	12	-
13	-	14	-
15	GND	16	-
Mechanical key			
17	-	18	GND
19	-	20	-
21	GND	22	PERST#
23	SATA Rxp	24	+3.3Vaux
25	SATA Rxn	26	GND
27	GND	28	+1.5V
29	GND	30	-
31	SATA Txn	32	-
33	SATA Txp	34	GND
35	GND	36	USB D-
37	GND	38	USB D+
39	+3.3Vaux	40	GND
41	+3.3Vaux	42	-
43	GND	44	-
45	-	46	-
47	-	48	+1.5V
49	-	50	GND
51	GND	52	+3.3Vaux

2.4.4 mini-PCle Slot

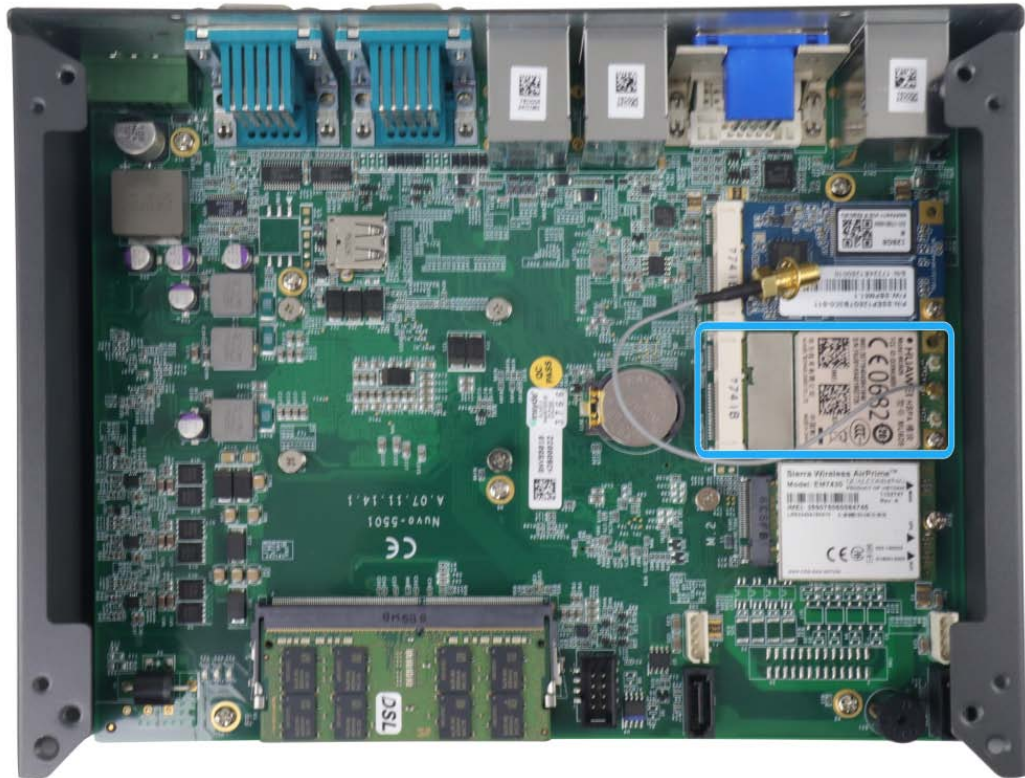

Nuvo-5501 series provides a mini-PCle socket compliant with mini-PCle specification rev. 1.2. There are plenty of off-the-shelf mini-PCle modules with versatile capabilities. By installing a mini-PCle module, your system can have expanded features such as WIFI, GPS, CAN bus, analog frame grabber, etc.

For SMA antenna installation, there are dedicated openings located on the right side of chassis.



mini-PCle slot definition

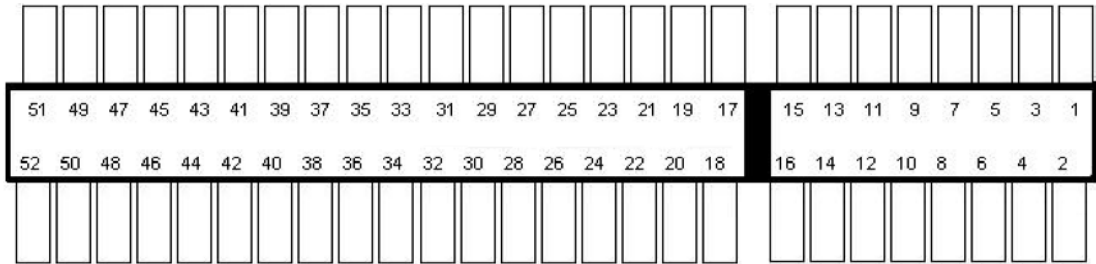

Pin #	Signal	Pin #	Signal
1	WAKE#	2	+3.3Vaux
3	COEX1	4	GND
5	COEX2	6	+1.5V
7	CLKREQ#	8	UIM PWR
9	GND	10	UIM DATA
11	REFCLK-	12	UIM CLK
13	REFCLK+	14	UIM RESET
15	GND	16	UIM VPP
Mechanical Key			
17	Reserved* (UIM C8)	18	GND
19	Reserved* (UIM C4)	20	W DISABLE#
21	GND	22	PERST#
23	PERn0	24	+3.3Vaux
25	PERp0	26	GND
27	GND	28	+1.5V
29	GND	30	SMB CLK
31	PETn0	32	SMB DATA
33	PETp0	34	GND
35	GND	36	USB D-
37	GND	38	USB D+
39	+3.3Vaux	40	GND
41	+3.3Vaux	42	LED WWAN#
43	GND	44	LED WLAN#
45	Reserved	46	LED WPAN#
47	Reserved	48	+1.5V
49	Reserved	50	GND
51	Reserved	52	+3.3Vaux

2.4.5 M.2 2242 and SIM Card Slot

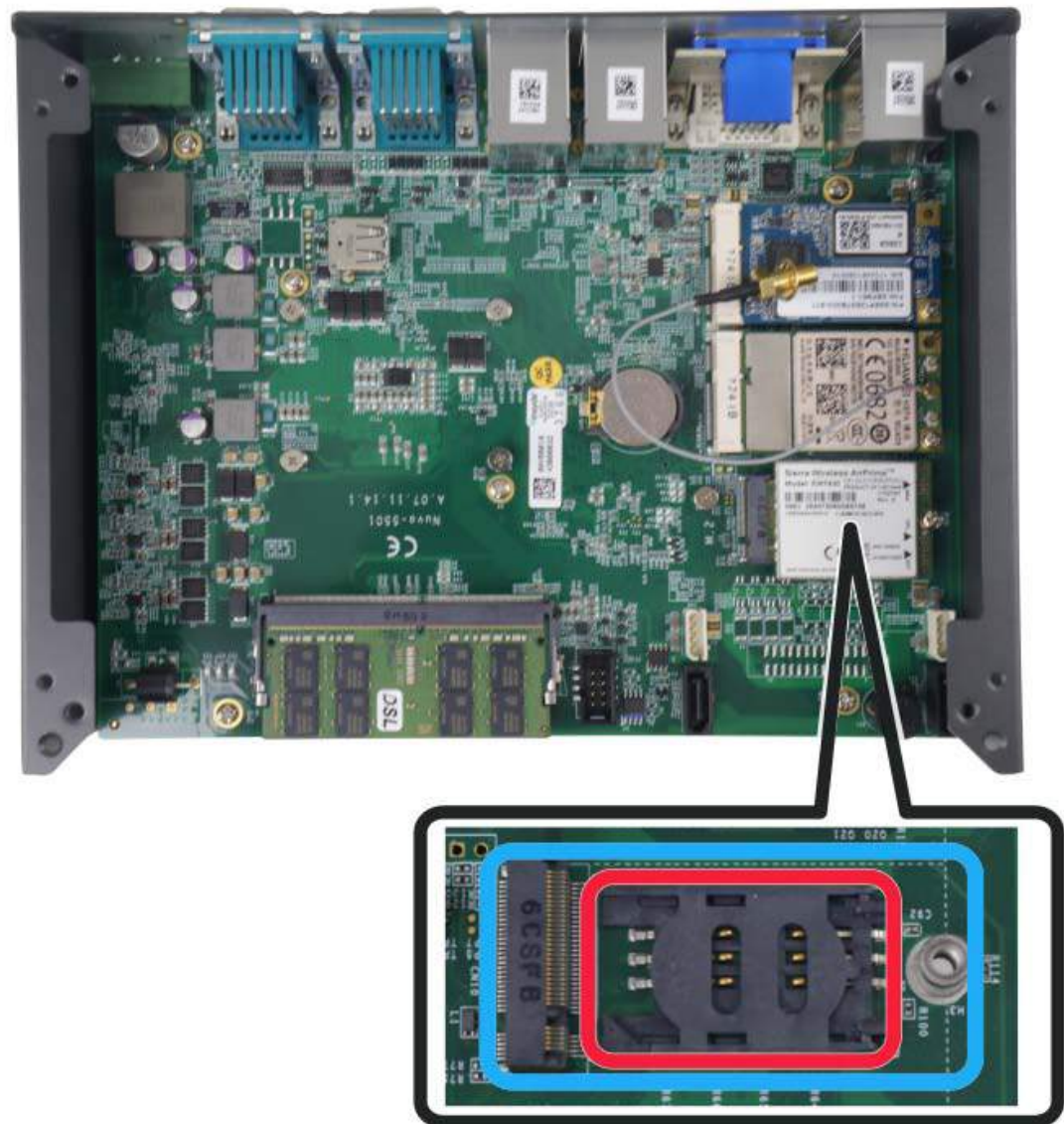

The system has a M.2 2242 (indicated in **blue**) slot that works in cooperation with a SIM slot (indicated in **red**). By installing a M.2 module, you can install a 3G/ 4G module with a SIM card for internet access via your service provider's 3G/ 4G network.

For wireless 3G/ 4G communication, SMA antenna apertures can be located on the right side of chassis for multi-antenna configuration.

M.2 Slot Pin Definition

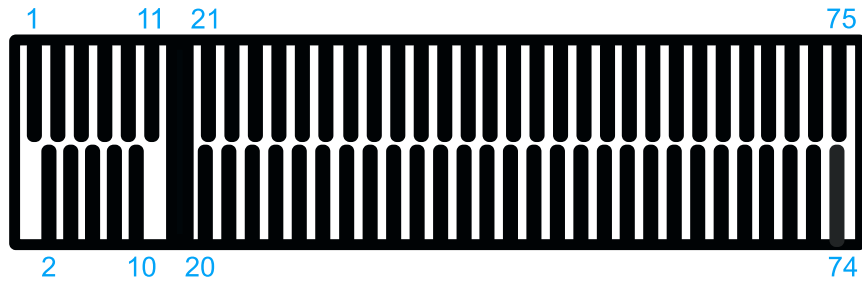

Pin #	Signal	Pin #	Signal
1	-	2	P3V3
3	GND	4	P3V3
5	GND	6	-
7	USB D+	8	-
9	USB D-	10	-
11	GND	12	KEY
13	KEY	14	
15		16	
17		18	
19	-	20	-
21	-	22	-
23	-	24	-
25	-	26	-
27	GND	28	-
29	-	30	UIM RST
31	-	32	UIM CLK
33	GND	34	UIM DATA
35	-	36	UIM PWR
37	-	38	-
39	GND	40	-
41	-	42	-
43	-	44	-
45	GND	46	-
47	-	48	-
49	-	50	PLTRST
51	GND	52	-
53	-	54	-
55	-	56	-
57	GND	58	-
59	-	60	-
61	-	62	-
63	-	64	-
65	-	66	-
67	PLTRST	68	-
69	-	70	P3V3
71	GND	72	P3V3
73	GND	74	P3V3
75	-		

2.4.6 SATA Port

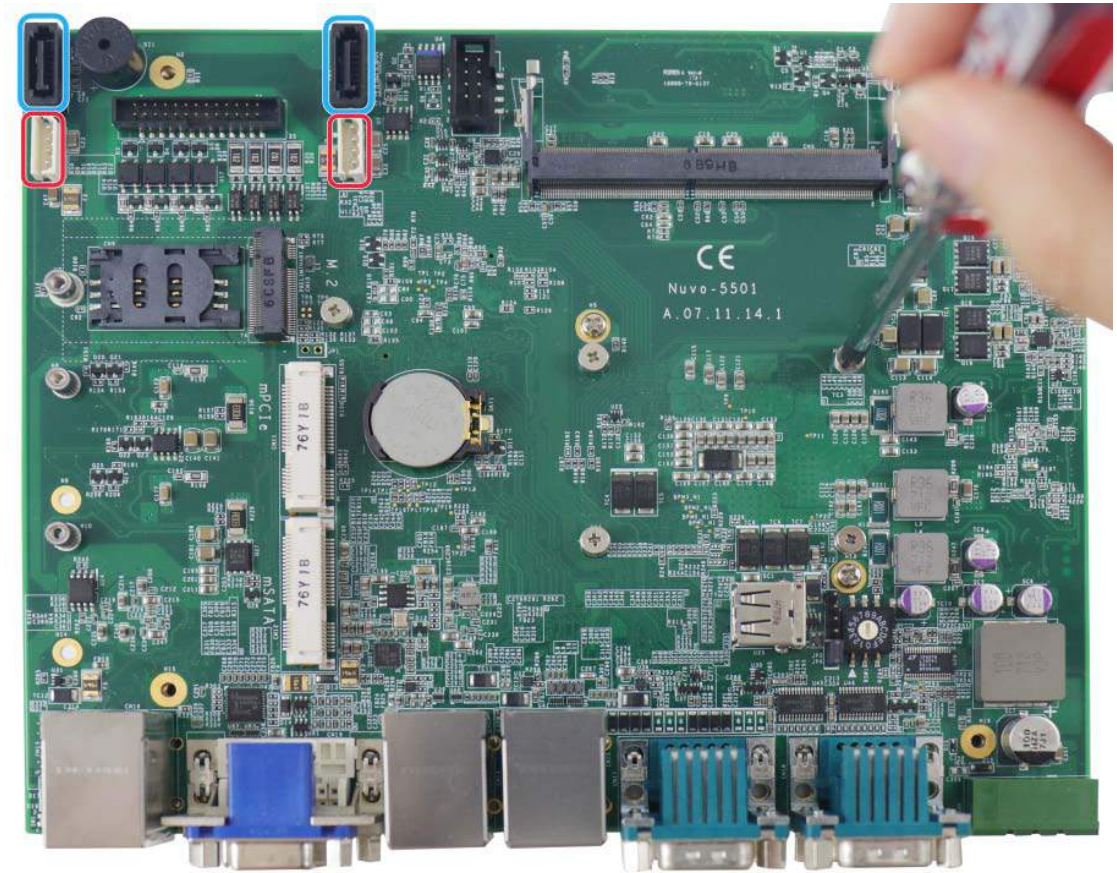

Nuvo-5501 series provides two SATA ports which support Gen3, 6 Gb/s SATA signals. Each SATA port is composed of a 7-pin SATA connector (indicated in **blue**) and a 4-pin power connector (indicated in **red**). A dedicated cable is shipped with the system to provide standard 22-pin SATA connector.

2.4.7 Internal USB Port

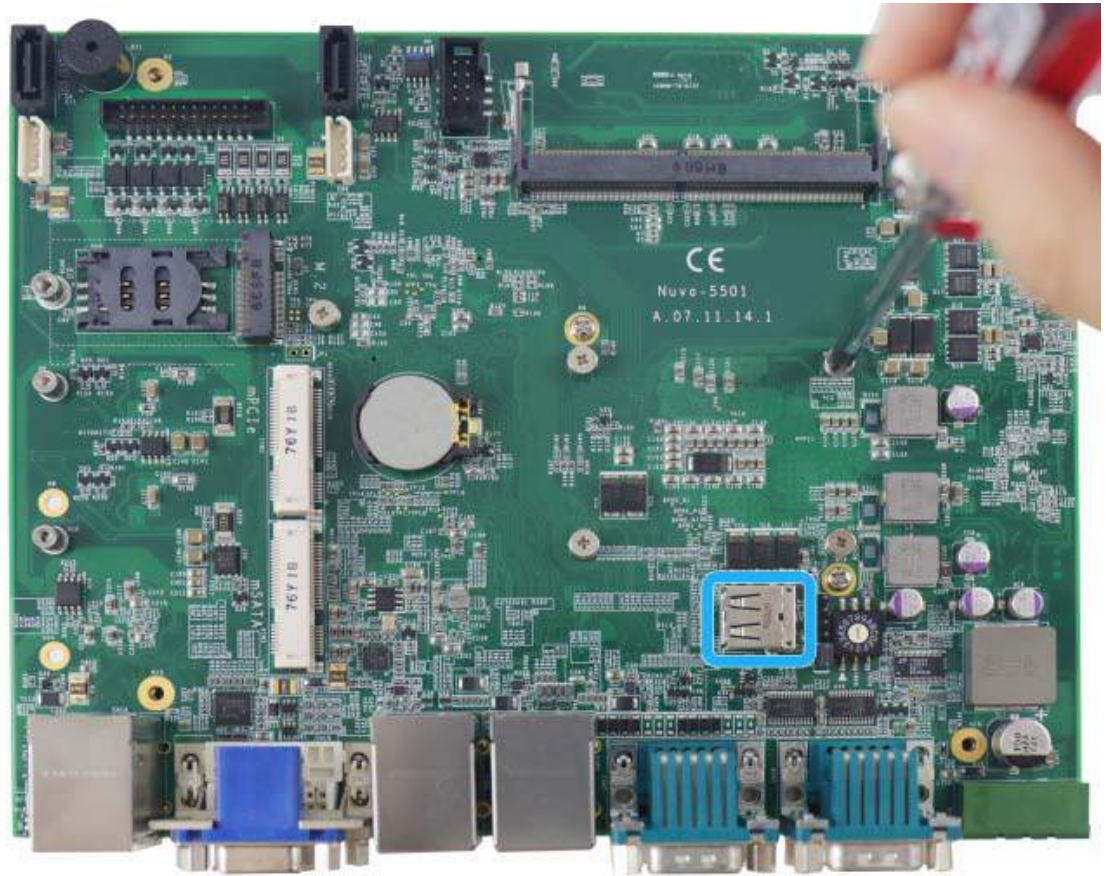

Nuvo-5501 series provides one additional USB port internally on the PCBA. It supports standard USB 2.0 signals. You can utilize this USB port to connect a USB protection dongle inside the chassis of Nuvo-5501 controller.

3 System Installation

Before disassembling the system enclosure and installing components and modules, please make sure you have done the following:

- It is recommended that only qualified service personnel should install and service this product to avoid injury or damage to the system.
- Please observe all ESD procedures at all times to avoid damaging the equipment.
- Before disassembling your system, please make sure the system has powered off, all cables and antennae (power, video, data, etc.) are disconnected.
- Place the system on a flat and sturdy surface (remove from mounts or out of server cabinets) before proceeding with the installation/ replacement procedure.

3.1 Disassembling the System

To access system internal components, the system needs to be disassembled. To disassemble the system enclosure, you need to remove screws on the I/O panel, removable and side panel.

1. On the I/O panel side, unscrew the three (3) screws shown below.



2. Unscrew the four(4) screws shown on top of the enclosure.



3. Unscrew the three (3) screws (indicated in blue) to remove the rear panel.



4. Unscrew the four (4) screws at the bottom of the system holding the four rubber stands.



5. Gently lift and remove the bottom panel.



6. For Nuvo-5501-DIO, you must disconnect the DIO connection cable to the motherboard before you can remove the enclosure completely.



3.2 CPU Installation

1. **DO NOT** remove the CPU from its container / tray before it is ready to be installed.
2. With the enclosure panels removed, to access the CPU socket, please do the following:
 - i. If you are installing a CPU for the first time, remove the four (4) screws indicated in **blue**.
 - ii. If you see the five (5) screws indicated in **red**, the system may already have a CPU installed. To gain access to the CPU socket, you will also need to remove the five (5) screws indicated in **red**.

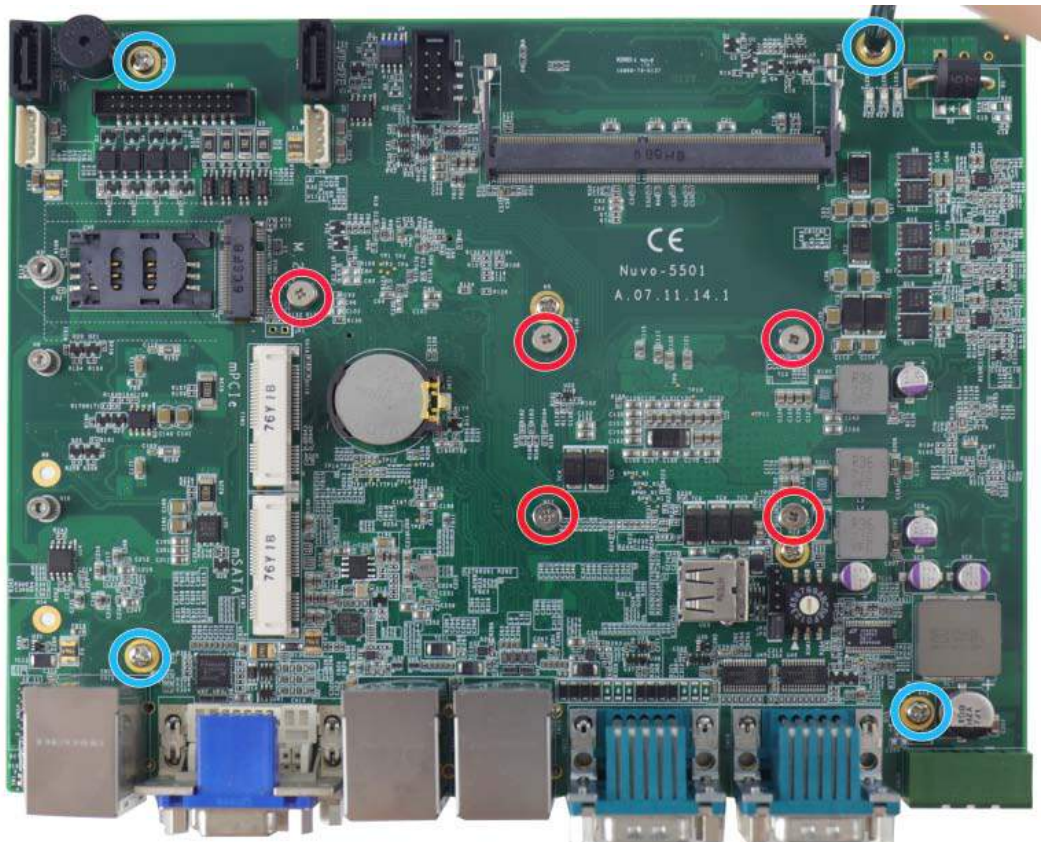

3. Between the motherboard and the heatsink, you'll see the CPU socket protective cover, place finger tips underneath the sign "REMOVE" for leverage and gently lift the cover.



WARNING

With the protective cover removed, please be careful when handling the motherboard. DO NOT touch the pins in the LGA socket!

4. Remove the CPU from its container/ tray. Match the two notches on the side to the protrusions in the socket, gently lower the CPU into the socket.



5. Locate the CPU retention bracket from the accessory box. Place the retention bracket on the CPU and hold it in place.



6. Turn the motherboard around and secure the bracket by tightening two M3 P-head screws.

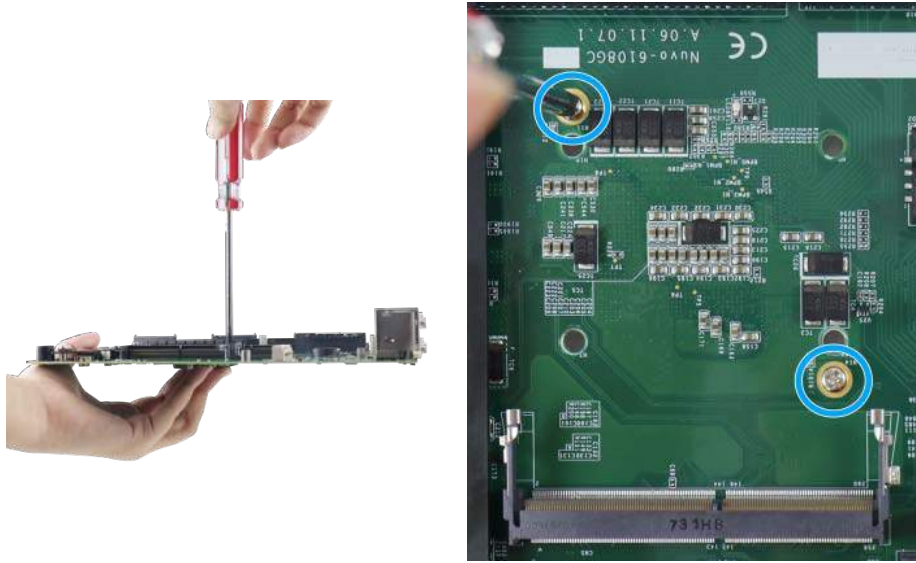

Hold CPU bracket firmly and turn the motherboard around

Secure two M3 P-head screws

7. Remove all thermal pads' protective films on the heatsink.

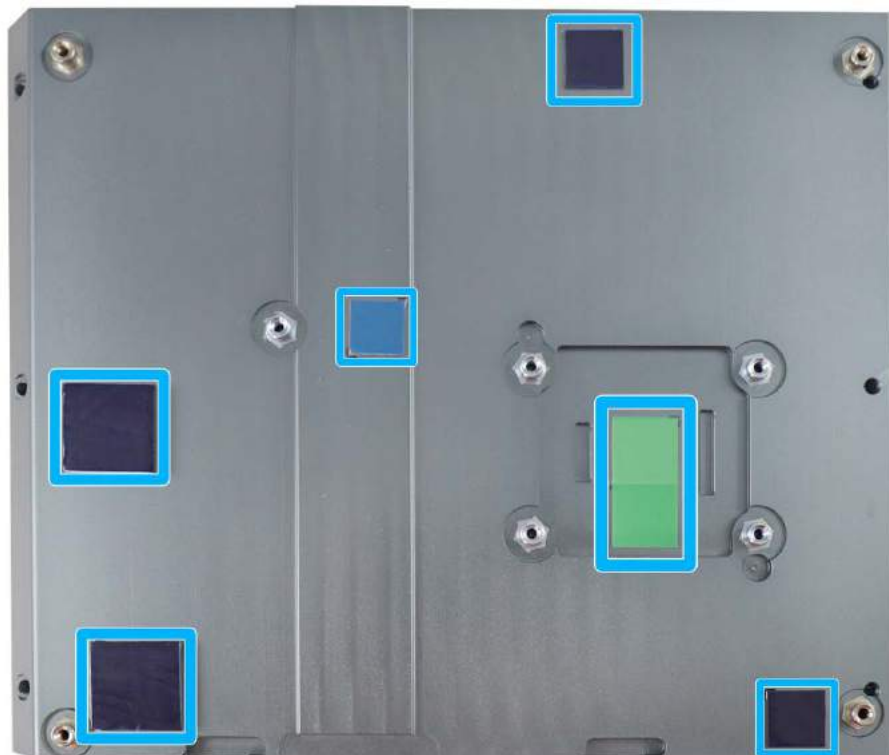

8. With the five motherboard standoffs aligned, gently lower the motherboard onto the heatsink.

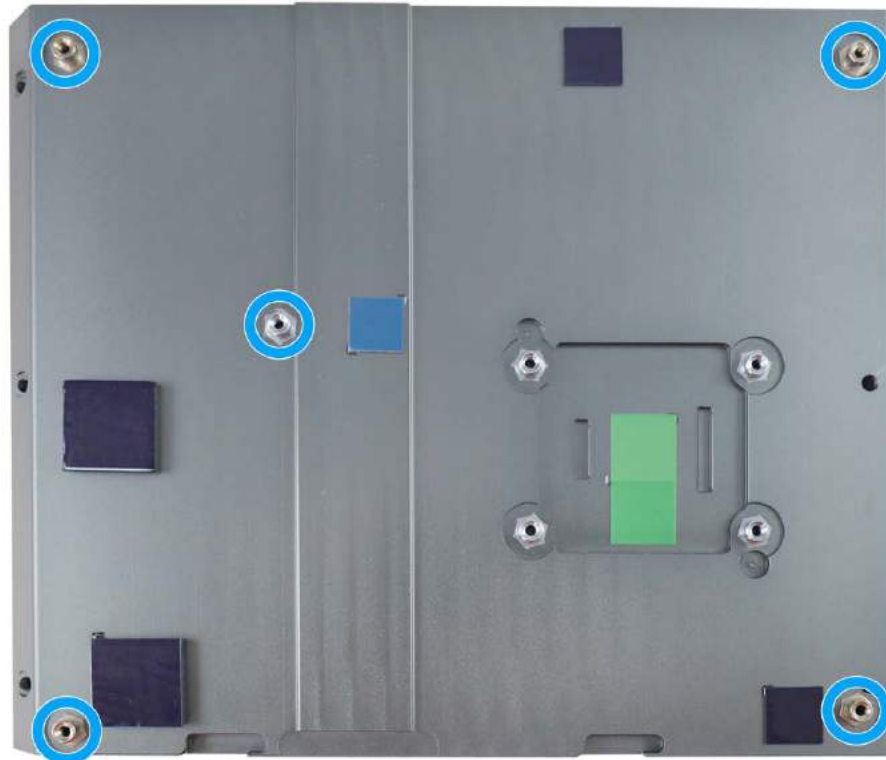

9. Secure the four (4) M3 P-head motherboard screws (indicated in blue) and from the accessory box, five (5) M3 spring screws (indicated in red). Gradually tighten the five screws in the following order for even pressure.

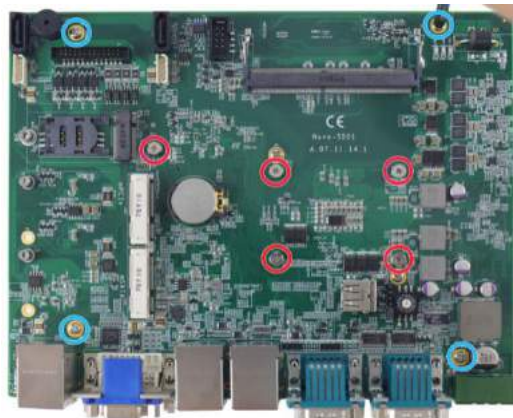

Securing the motherboard

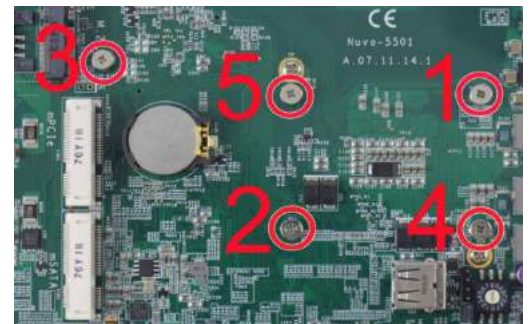

Secure five CPU/ heatsink spring screws in order

10. [Reinstall the system enclosure](#) and panel when done.

If you need to install other components, please refer to respective sections.

3.3 DDR4 SO-DIMM Installation

There is a single memory SO-DIMM slot on the motherboard that supports up to 16GB DDR4-2133. Please follow the procedures below to replace or install the memory modules.

1. Please refer to the section "[Disassembling the System](#)", you may not need to completely dismantle the system to gain access to the memory module slots.
2. Locate the SODIMM memory module slot on the motherboard.
3. To install the memory module, insert gold fingers of the module into the slot at 45 degree angle, push down on the edge of the module and the clips on the side should clip the module into position.



4. Push the memory module down until it is clipped-in.

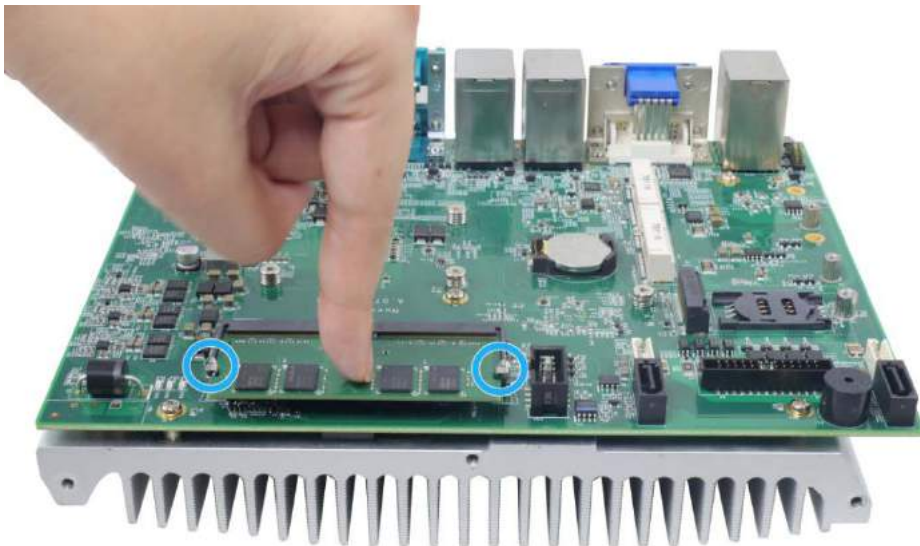

5. [Reinstall the system enclosure](#) and panel when done.

If you need to install other components, please refer to respective sections.

3.4 Installing M.2 Module

The system has a M.2 slot (indicated in **blue**) coupled with SIM socket (indicated in **red**) for installing 3G/ 4G module. For installation, please refer to the following instructions.

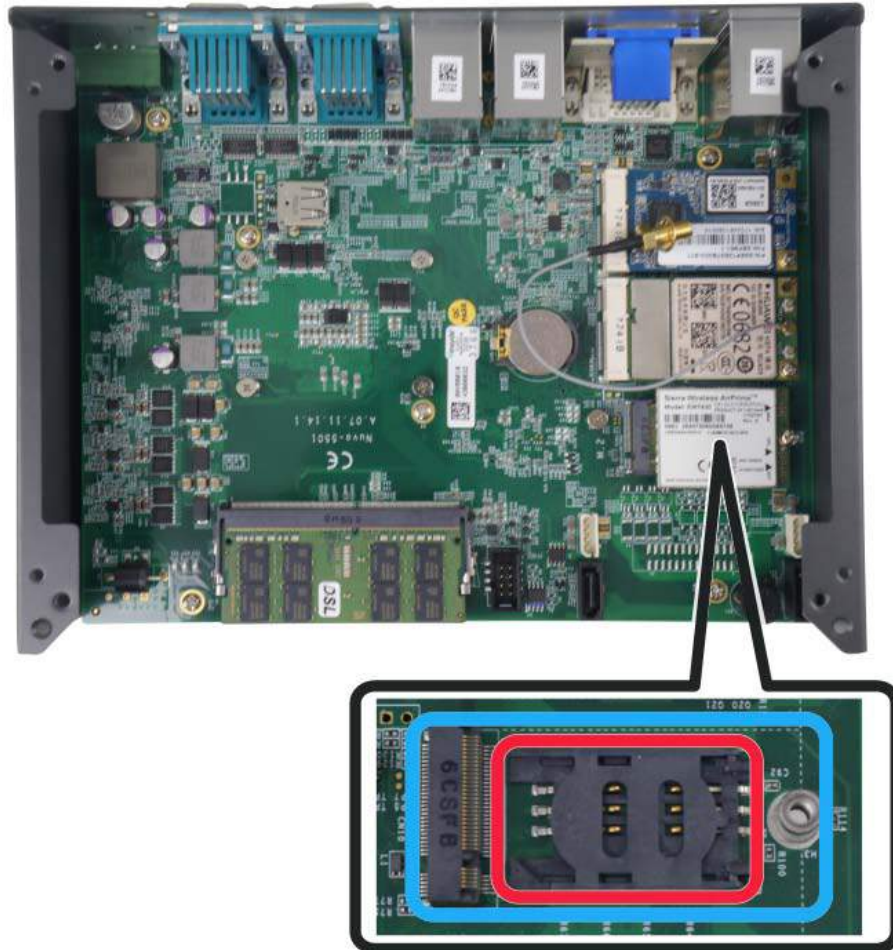

1. Please refer to the section "[Disassembling the System](#)", you may not need to completely dismantle the system to gain access to the M.2 slot and SIM socket.

2. Before installing the M.2 module, you need to insert the SIM card. Slide the SIM slot towards the outside of the motherboard and lift the SIM card holder. Insert the SIM card (pins facing up), and slide it towards the left to lock the SIM card in-place.



3. Shut the SIM holder and secure it by sliding the holder towards the center of the motherboard.



4. Insert the M.2 module on a 45 degree angle into the M.2 slot.



5. Secure the M.2 module.



6. Clip on the IPEZ-to-SMA cable to the module (please refer to the module's user manual on antennae cable connection)

- Secure the antenna to the enclosure panel.

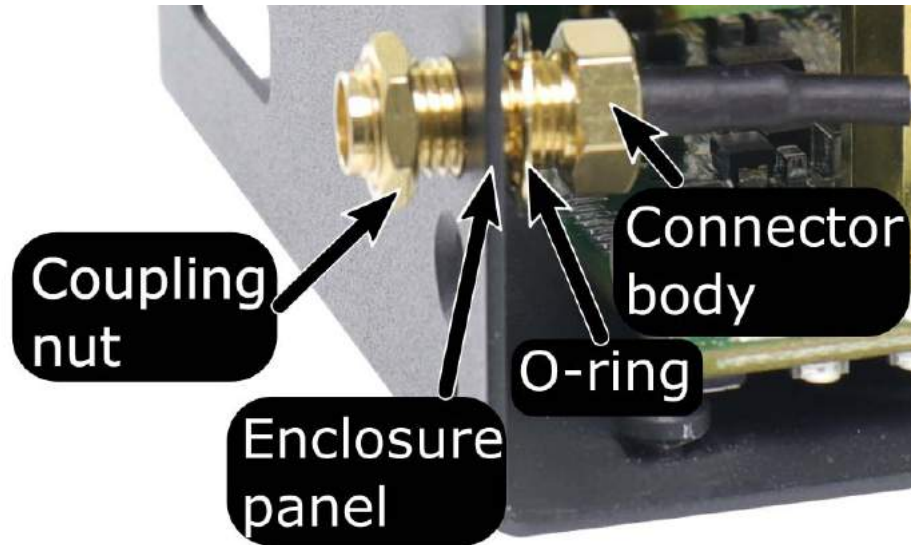

- [Reinstall the system enclosure](#), panel and attach the external antenna.



If you need to install other components, please refer to respective sections.

3.5 Installing mini-PCle Module

The system has one mini-PCle slot. To install a mini-PCle module, please refer to the following instructions.



1. Please refer to the section "[Disassembling the System](#)", you may not need to completely dismantle the system to gain access to the mini-PCle slot.
2. Insert the module on a 45 degree angle.



3. Gently press down and secure the module with two M2.5 P-head screws



4. Clip on the IPEZ-to-SMA cable to the module and secure the antenna to the side panel. Please refer to the module's manual for clip-on connection.

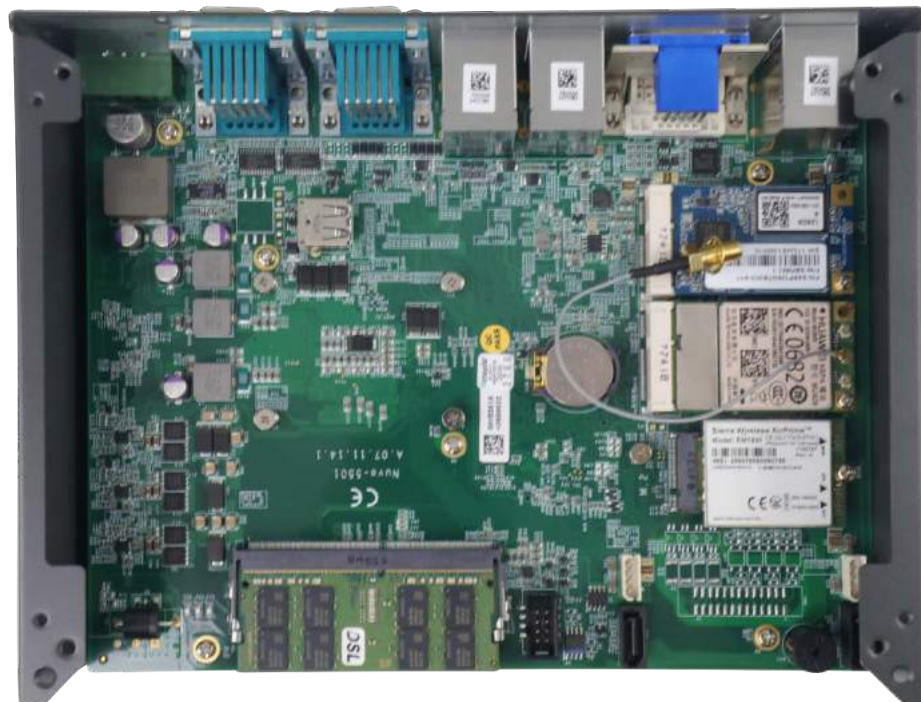

- Secure antenna to side panel

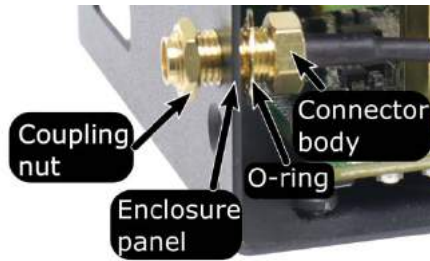

Antenna installation

Secure on side panel

- [Reinstall the system enclosure](#), panel and external antenna.



If you need to install other components, please refer to respective sections.

3.6 Installing 2.5” HDD/ SSD or 3.5” HDD to SATA Port

The system has two SATA ports, but only one HDD or SSD can be installed in the system. Please refer to the following instructions on how to install 2.5” SATA HDD/SSD or a 3.5” SATA HDD into the system.

3.6.1 Installing 2.5” HDD/ SSD (Post 2019)



NOTE

This 2.5” hard drive installation method is applicable to Nuvo-5501 systems purchased after Jan. 1st, 2019.

1. Please refer to the section [“Disassembling the System”](#) to gain access to SATA port.
2. Secure 2.5” HDD/ SSD on the HDD/SSD bracket with 4 M3 flat-head screws.



3. Secure 2.5” HDD/ SSD and the bracket onto the chassis with M3 flat head screw.



4. Connect 2.5" HDD/ SSD to the motherboard with SATA (indicated in **blue**) and power (indicated in **red**) cable.

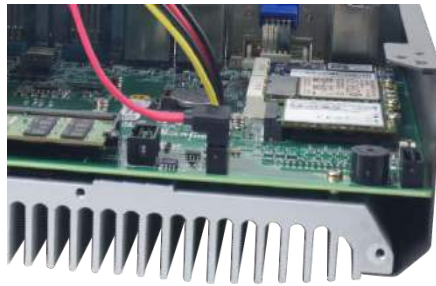

Cable connections



SATA/ power connectors



5. [Reinstall the system enclosure](#) and panel when done.

If you need to install other components, please refer to respective sections.

3.6.2 Installing 2.5" HDD/ SSD (Pre 2019)



NOTE

This 2.5" hard drive installation method is applicable to Nuvo-5501 systems purchased before Jan. 1st, 2019.

1. Please refer to the section "[Disassembling the System](#)" to gain access to SATA port.
2. Secure 2.5" HDD/ SSD on the HDD/SSD bracket with 4 M3 flat-head screws.



3. Secure 2.5" HDD/ SSD and the bracket on the chassis with #6-32 flat head screw.



4. Connect 2.5" HDD/ SSD to the motherboard with SATA (indicated in **blue**) and power (indicated in **red**) cable.



Cable connections

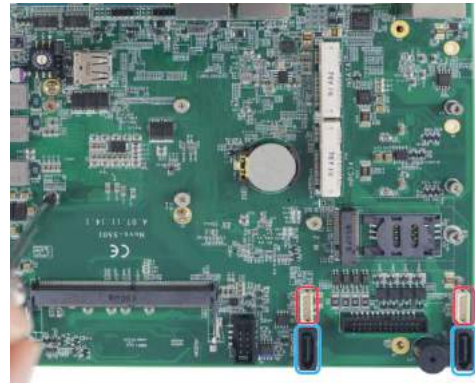

SATA/ power connectors



5. [Reinstall the system enclosure](#) and panel when done.

If you need to install other components, please refer to respective sections.

3.6.3 Installing 3.5" HDD (Post 2019)



NOTE

This 2.5" hard drive installation method is applicable to Nuvo-5501 systems purchased after Jan. 1st, 2019.

1. Please refer to the section "[Disassembling the System](#)" to gain access to SATA port.
2. Secure 3.5" HDD on the HDD/SSD bracket with #6-32 flat-head screws.



3. Secure 3.5" HDD and the bracket on the chassis with M3 flat head screw.



4. Connect 3.5" HDD/ SSD to the motherboard with SATA (indicated in **blue**) and power (indicated in **red**) cable.

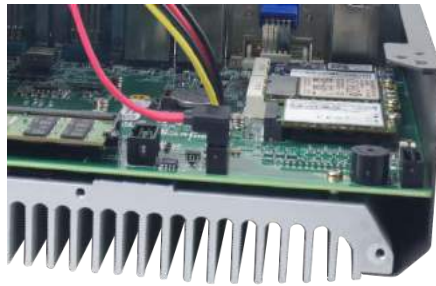

Cable connections



SATA/ power connectors



5. [Reinstall the system enclosure](#) and panel when done.

If you need to install other components, please refer to respective sections

3.6.4 Installing 3.5" HDD (Pre 2019)



NOTE

This 2.5" hard drive installation method is applicable to Nuvo-5501 systems purchased before Jan. 1st, 2019.

1. Please refer to the section "[Disassembling the System](#)" to gain access to SATA port.
2. Secure 3.5" HDD and bracket onto the chassis with 4 M3 flat-head screws.



3. Connect 3.5" HDD to the motherboard with SATA (indicated in **blue**) and power (indicated in **red**) cable.



Cable connections



SATA/ power connectors



4. [Reinstall the system enclosure](#) and panel when done.

If you need to install other components, please refer to respective sections.

3.7 Installing the System Enclosure

To reinstall the system enclosure, please follow the steps below:

1. For Nuvo-5501-DIO systems, connect the DIO cable onto the motherboard DIO connector (indicated in blue).



2. With the heatsink upside-down, gently lower the enclosure.



- Place the four rubber stand and secure the four (4) screws at the bottom of the system panel.



- Secure the three (3) screws on the rear panel.



- Turn the system around with the heatsink on top, secure the four(4) screws at the top of the enclosure.



- Secure the three(3) screws on the IP panel to complete the enclosure installation procedure.



3.8 Mounting Nuvo-5501 Series

Neosys provides versatile mounting methods for Nuvo-5501 series systems. You can use wall-mounting brackets shipped with Nuvo-5501 series to mount it on the wall. Neosys also offers optional DIN-rail mounting kit to mount it on a DIN-rail. To mount your Nuvo-5501 controller, please refer to the instructions listed below.

3.8.1 Installing Wall-Mounting Bracket

Nuvo-5501 series is shipped with two wall-mounting brackets as the standard mounting option. Please follow steps below to mount your Nuvo-5501 controller on a flat surface.

1. Get two wall-mounting brackets and four M4 screws from the accessory box.
Fix the mounting brackets to Nuvo-5501 using M4 screws.

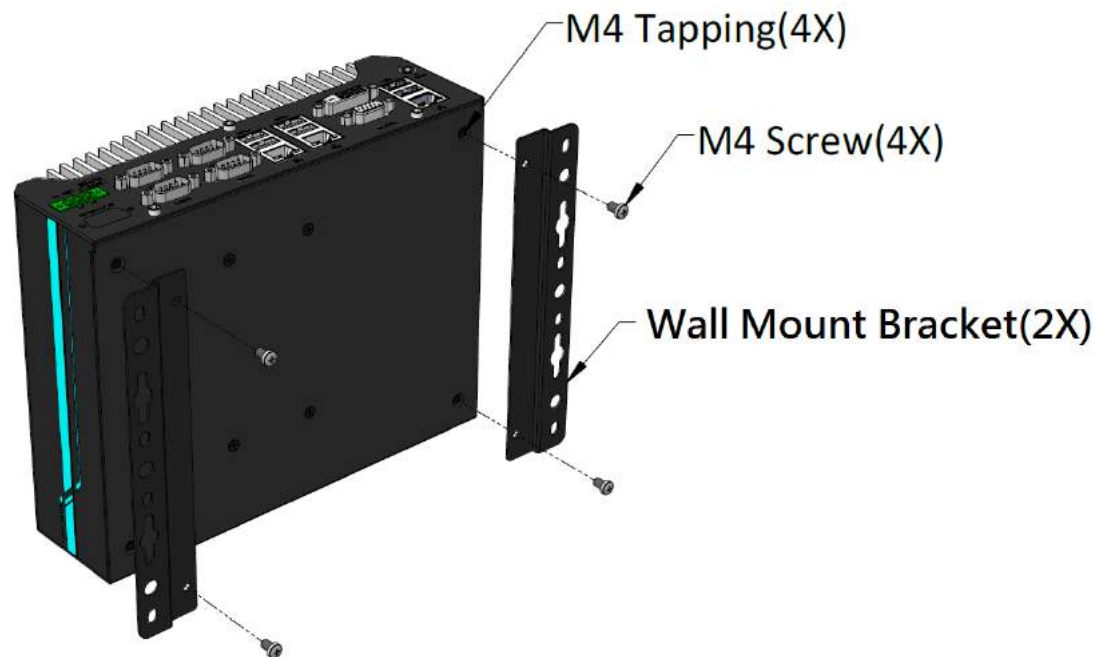

- Place Nuvo-5501 controller on a wall or flat surface and fix it with screws.

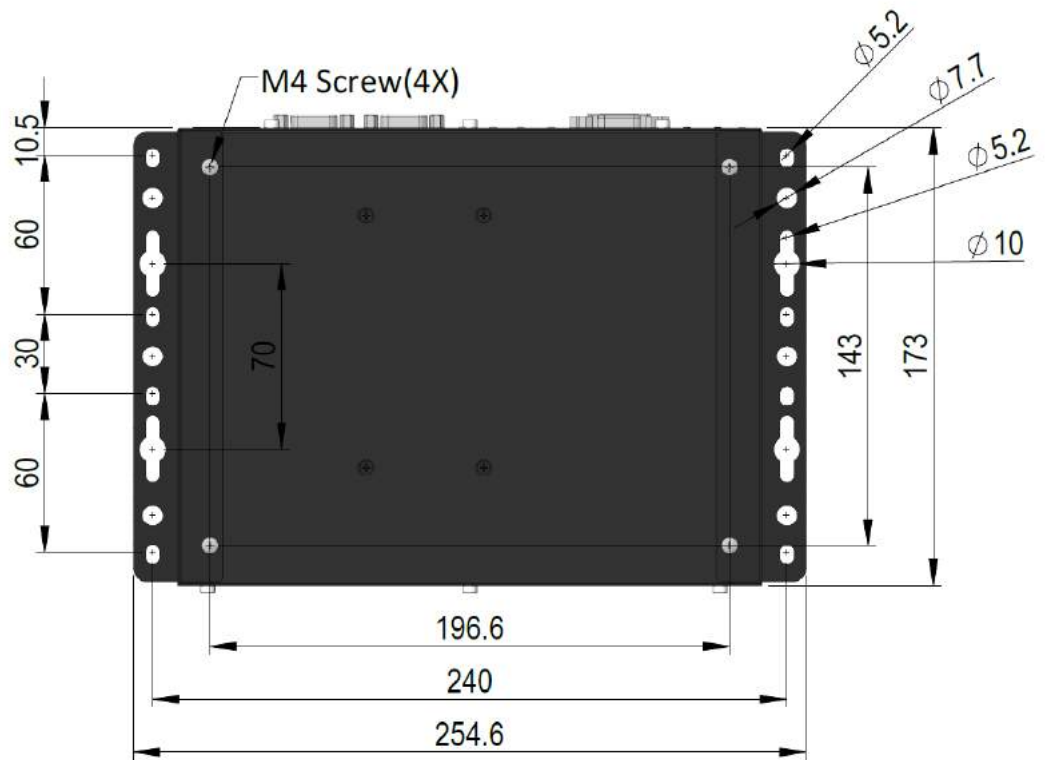

3.8.2 Installing DIN-Rail Mounting Kit (Optional)

The kit includes a bracket and a DIN-rail mounting clip. You should fix the clip to the bracket using four M4 flat-head screws first, and then fix the bracket assembly to the Nuvo-5501 controller with another four M4 screws. This option can be useful if you want to deploy it inside an equipment cabinet where DIN-rail is available.

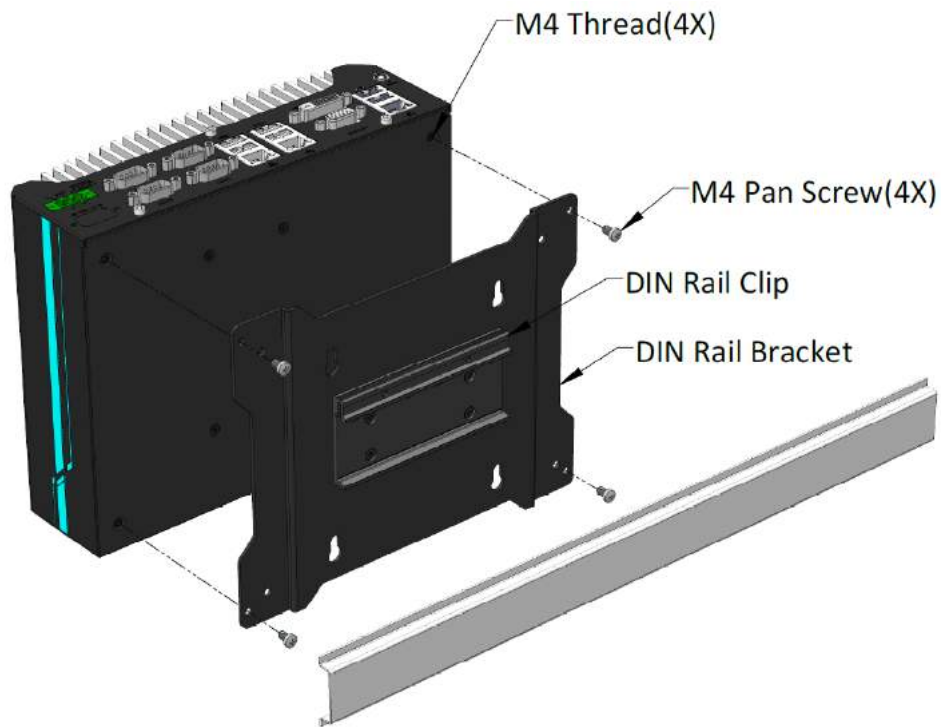

4 BIOS Settings

The system is shipped with factory-default BIOS settings meticulously programmed for optimum performance and compatibility. In this section, we'll illustrate some of BIOS settings you may need to modify. Please always make sure you understand the effect of change before you proceed with any modification. If you are unsure of the function you are changing, it is recommended to change one setting at a time to see its effect(s).

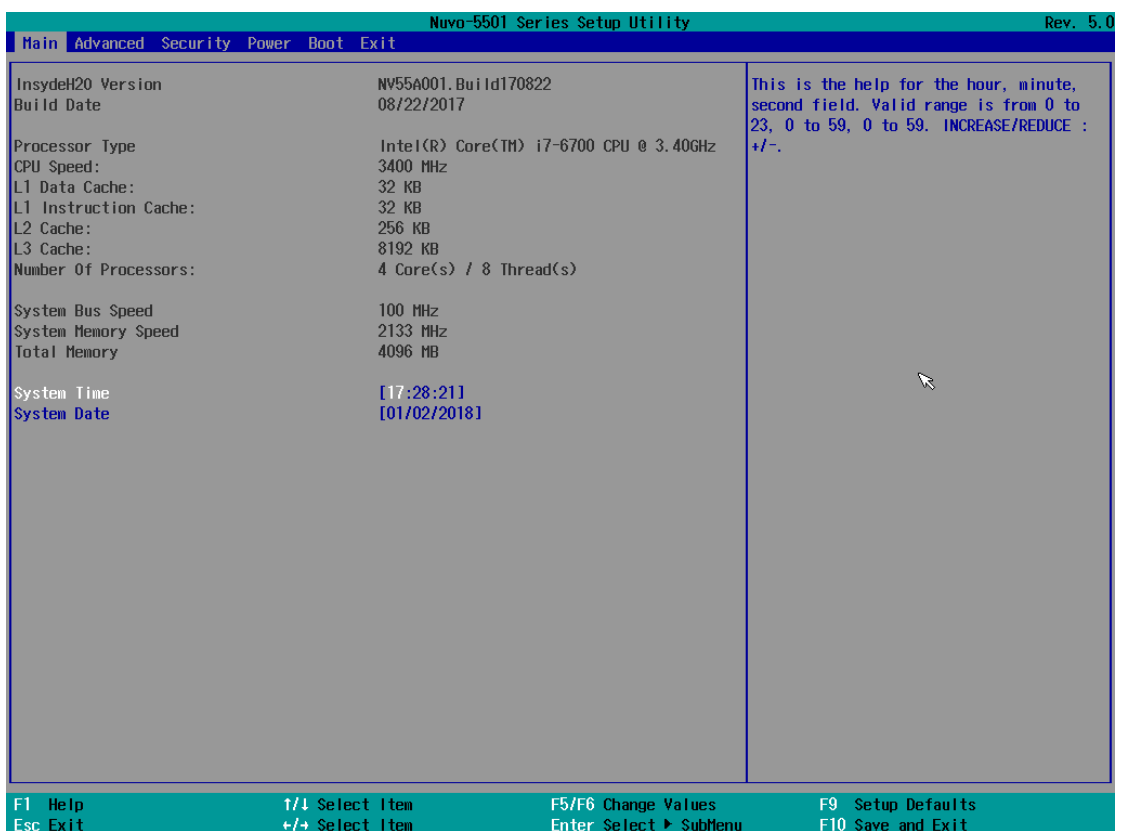

NOTE

Not all BIOS settings will be discussed in this section. If a particular setting/ function you are after requires specific BIOS settings but is not discussed in this section, please contact Neousys Technical Support staff.

4.1 COM1 & COM2 Configuration

There are a total of four COM ports implemented on Nuvo-5501 series. The system's COM1 and COM2 support RS-232 (full-duplex), RS-422 (full-duplex) and RS-485 (half-duplex) mode, while COM3 and COM4 support RS-232 mode only. You can set the COM1/ COM2 operating mode via BIOS settings.

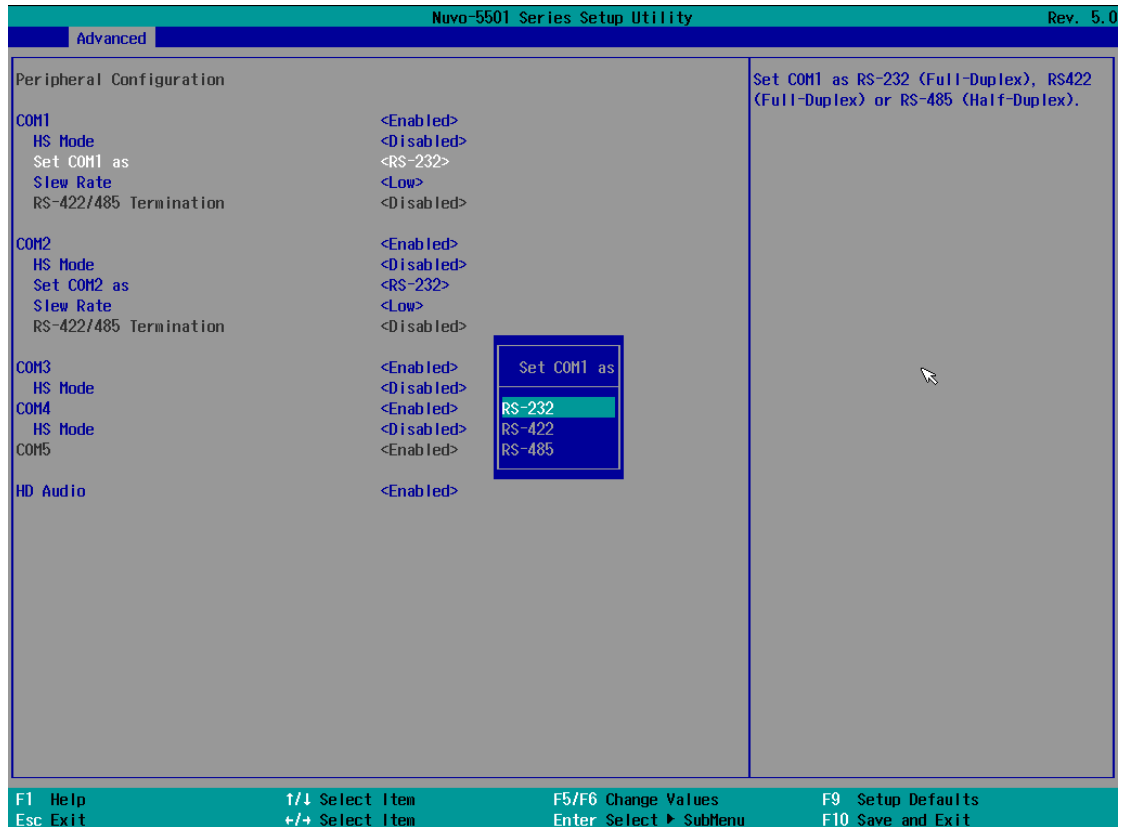

Another option in the BIOS called “**Slew Rate**” defines how sharp the rise/ fall edge is for the output signal of COM1/ COM2. For long-distance RS-422/ 485 transmission, you may set the “**Slew Rate**” option as “High” to improve signal quality.

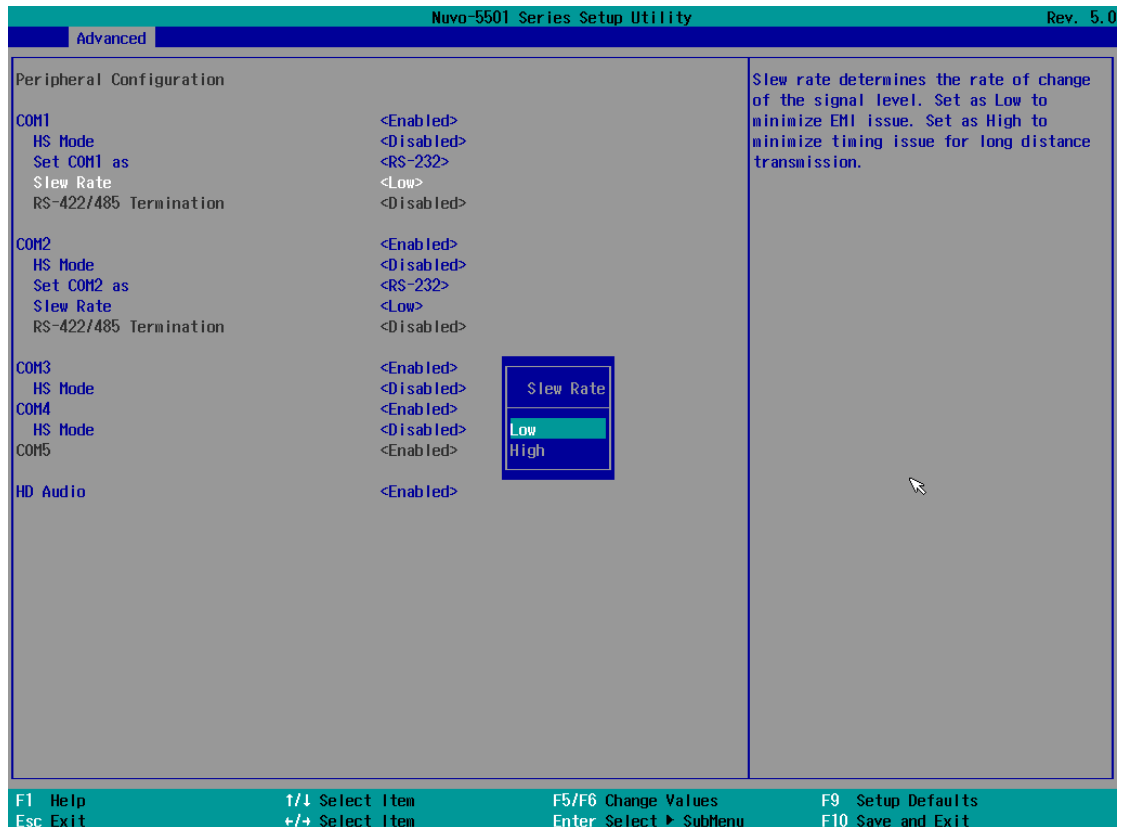

For RS-422/485 communication, the “**RS-422/485 Termination**” option determines whether to enable/disable internal termination of RS-422/485 transceiver according to your wiring configuration (e.g. with or without external termination).

To set COM port operating mode:

1. When system boots up, press F2 to enter BIOS setup utility.
2. Go to **[Advanced] > [Peripheral Configuration]**.
3. Highlight the COM port you wish to set and press Enter to bring up setting options. Scroll to and highlight the setting you wish to set and press Enter.
4. Repeat step 2 to set other COM ports.

Press F10 to “Exit Saving Changes”.

4.2 Power On After Power Failure Option

This option defines the behavior of system when DC power is supplied.

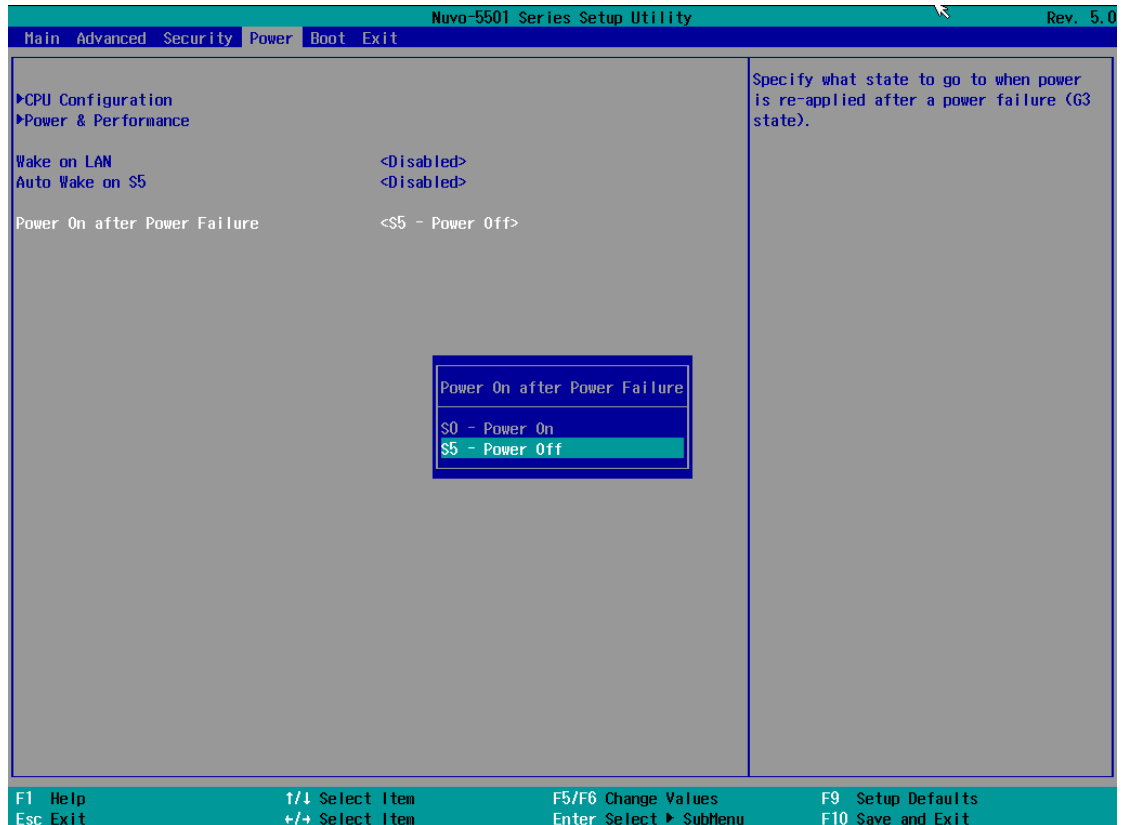

Value	Description
S0 – Power On	System is powered on when DC power is supplied.
S5 – Power Off	System is kept in off state when DC power is supplied.

To set “Power On after Power Failure” option:

1. When system boots up, press F2 to enter BIOS setup utility.
2. Go to **[Power] > [Power On after Power Failure]**.
3. Scroll down to highlight **[Power On after Power Failure]**, press Enter to bring up setting options, S0 – Power On or S5 – Power Off, and press Enter to select the setting.
4. Press F10 to “Exit Saving Changes”.

4.3 Power & Performance (CPU SKU Power Configuration)

The system supports various 6th-Gen Skylake LGA1151 CPUs. A unique feature, “**SKU Power Config**” is implemented in BIOS to allow users to specify user-defined SKU power limit. Although the system is designed to have best thermal performance with CPUs of 35W TDP, you can install a 65W CPU and limit its SKU power (to35W) to obtain more computing power. This feature gives you the flexibility of CPU selection and great balance between computing power and operating temperature range.

To configure the CPU SKU power limit:

1. When the system boots up, press F2 to enter BIOS setup utility.
2. Go to **[Power]** → **[Power & Performance]**.

Select a proper value of SKU power limit for **[SKU Power Config]** option.



4.4 Wake on LAN Option

Wake-on-LAN (WOL) is a mechanism which allows you to turn on your system via Ethernet connection. To utilize Wake-on-LAN function, you have to enable this option first in BIOS settings. Please refer to “Powering On Using Wake-on-LAN” to set up the system.



To enable/disable “Wake on LAN” option:

1. When system boots up, press F2 to enter BIOS setup utility.
2. Go to **[Power] > [Wake on LAN]**.
3. Press Enter to bring up setting options, scroll to the setting you desire and press Enter to set.
4. Press F10 to “Exit Saving Changes.”

4.5 Boot Menu

The Boot menu in BIOS allows you to specify the system’s boot characteristics by setting bootable device components (boot media) and method. Or, you may press F12 upon system start up and select a device you wish boot from.

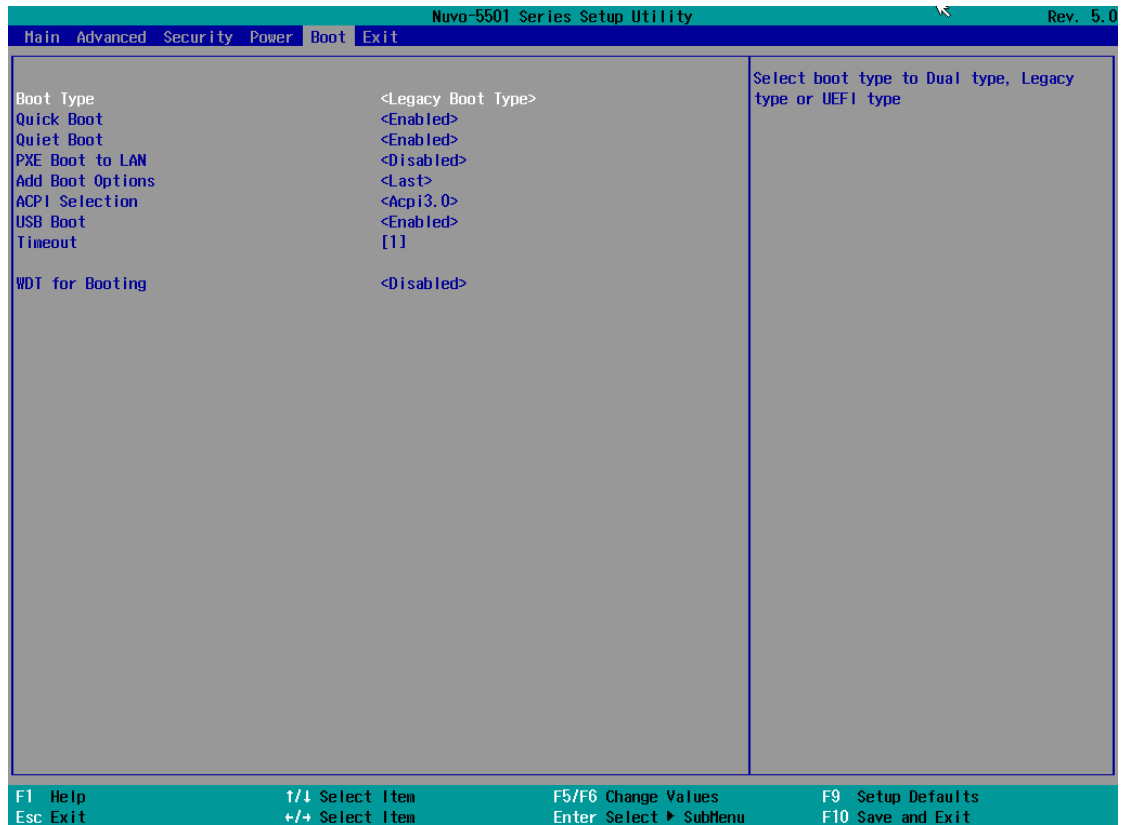

4.5.1 Boot Type (Legacy/ UEFI)

The system supports both Legacy and Unified Extensible Firmware Interface (UEFI) boot modes. UEFI is a specification proposed by Intel to define a software interface between operating system and platform firmware. Most modern operating systems, such as Windows 7/8/10 and Linux support both Legacy and UEFI boot modes. The Legacy boot mode uses MBR partition for disk and VBIOS for video initialization, the UEFI boot mode uses GPT partition which supports greater than 2TB partition size and GOP driver for faster video initialization.

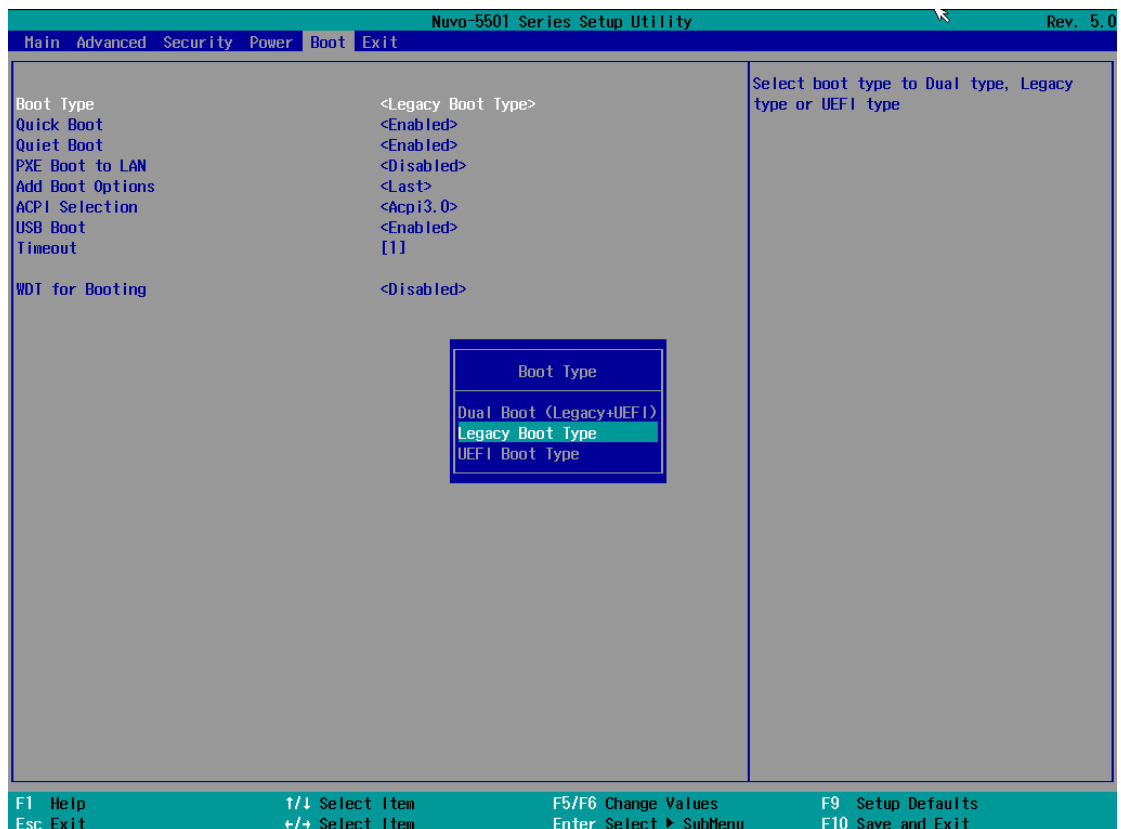

It is recommended that:

- If you need greater than 2TB disk partition, you shall choose UEFI boot mode and install operating system accordingly.
- Choose Legacy boot mode if the installed HDD/ SSD capacities are under 2TB

To configure Boot Type:

1. When system boots up, press F2 to enter BIOS setup utility.
2. Go to **[Boot] > [Boot Type]**, press Enter to bring up options, Dual Boot (Legacy+UEFI), Legacy Boot Type, UEFI Boot Type.
3. Highlight your selection and press Enter.
4. Press F10 to “Exit Saving Changes”.

4.5.2 Add Boot Options

The Add Boot Options dedicates the boot sequence order of a newly added device (eg. USB flash drive). The setting allows you to set the newly added device to boot first or as the last device on the list.

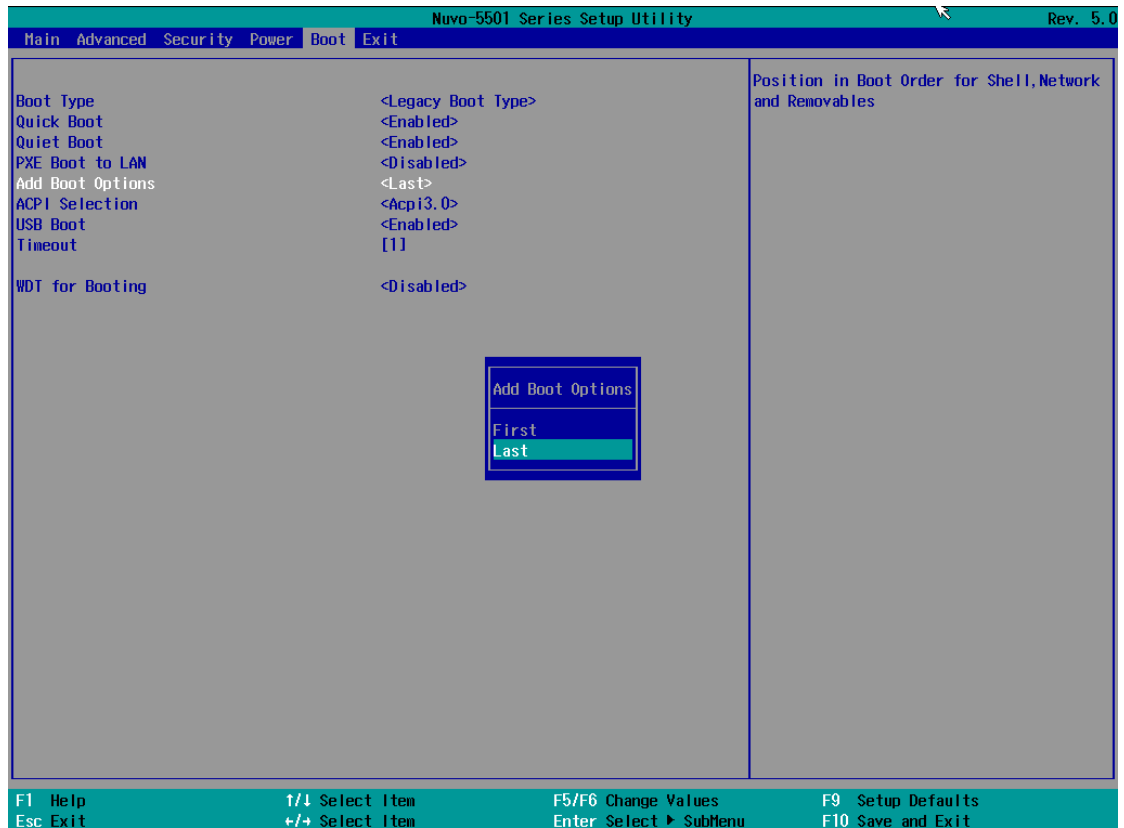

To set Add Boot Options:

1. When system boots up, press F2 to enter BIOS setup utility.
2. Go to [Boot] > [Add Boot Option], press Enter to bring up options, First or Last.
3. Highlight your selection and press Enter, press F10 to "Exit Saving Changes".

4.5.3 Watchdog Timer for Booting

The Watchdog timer setting in the BIOS ensures a successful system boot by specifying a timeout value. If the Watchdog timer is not stopped and expires, the BIOS will issues a reset command to initiate another boot process. There are two options in BIOS menu, “**Automatically after POST**” and “**Manually after Entering OS**”. When “**Automatically after POST**” is selected, the BIOS automatically stop the watchdog timer after POST (Power-On Self Test) OK. When “**Manually after Entering OS**” is selected, it’s user’s liability to stop the watchdog timer when entering OS. This guarantees the system can always boot into OS, otherwise another booting process will be initiated.

For information about programming watchdog timer, please refer to **Appendix A Watchdog Timer & Isolated DIO**.

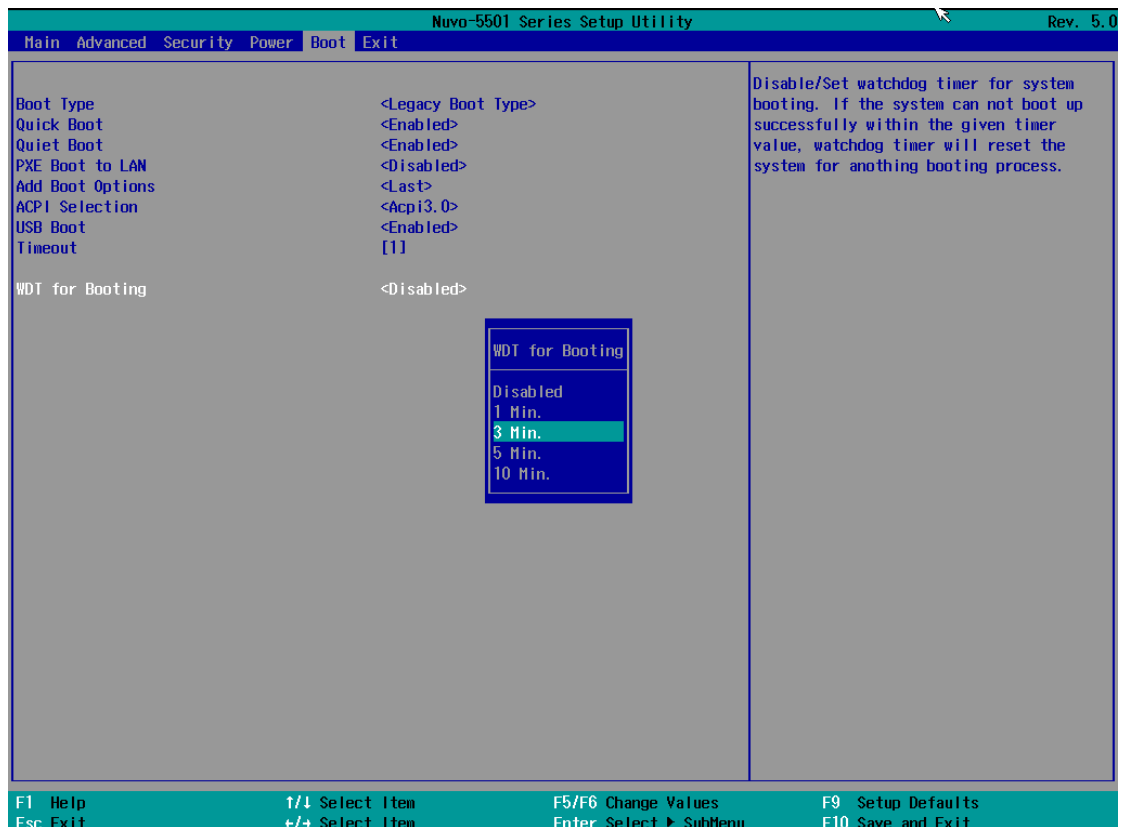

To set the watchdog timer for boot in BIOS:

1. When system boots up, press F2 to enter BIOS setup utility.
2. Go to **[Boot]** menu.
3. Disable or select timeout value for **[WDT for Booting]** option.
4. Once you give a timeout value, the **[WDT Stop Option]** option appears. You can select “*Automatically after POST*” or “*Manually after Entering OS*”.
5. Press F10 to “Exit Saving Changes.

4.5.4 Legacy/ UEFI Boot Device

When you wish to set a designated boot device, you may set it as the first device to boot in Legacy or UEFI Boot Device setting. Or if you wish to manually select a boot device, you may do so by pressing F12 when the system boots up.



To set boot order for devices in UEFI Boot Device:

1. When system boots up, press F2 to enter BIOS setup utility
2. Go to **[Boot] > [UEFI Boot Device]**
3. Highlight the device you wish to make boot order changes to and press F5/ F6 or +/- to change device boot order.

To select boot order for devices in Legacy Boot Device:

1. When system boots up, press F2 to enter BIOS setup utility
2. Go to **[Boot] > [Legacy Boot Device]**, you can choose the type of device to list by selecting "**By Device** or **By Device Type**".
3. Highlight the device you wish to make boot order changes to and press F5/ F6 or +/- to change device boot order.

5 OS Support and Driver Installation

5.1 Operating System Compatibility

The system supports most operating system developed for Intel® x86 architecture. The following list contains operating systems that have been tested by Neosys Technology.

- Microsoft Window 7 (x86*/ x64*)
- Microsoft Window 8 (x64)
- Microsoft Window 10 (x64)
- CentOS 7
- Debian 8.7
- Fedora 24
- OpenSUSE 42.1
- Ubuntu 14.04.4 LTS and 16.04 LTS



NOTE

** Due to xHCI driver is not included natively in Windows 7, you may encounter Keyboard/ mouse issues when installing Windows 7. Neosys offers a Windows-based batch file and step-by-step installation guide.*

Neosys may remove or update operating system compatibility without prior notice. Please contact us if your operating system of choice is not on the list.

5.2 xHCI Driver Support in Microsoft OS

Intel Skylake platform supports USB 2.0 and USB 3.0 connectivity through its xHCI controller. For **Windows 8/ 8.1** and **Windows 10**, xHCI controller is natively supported and therefore no issue is anticipated. To install Windows 8/ 8.1/ 10, please follow the recommended installation procedure by Microsoft. However, **Windows 7** does not natively support xHCI thus the xHCI driver needs to be manually patched in order to support both USB storage device and USB keyboard/mouse during the OS installation process.

If you would like to install Windows 7, the simplest way is to create a USB thumb drive with Windows 7 installation files and Intel xHCI driver included. Please follow instructions in the following sections to install Windows 7 on your system.

5.3 User Provided Items for Windows 7 Installation

Before we proceed with the creation of USB flash drive for installation, please make sure you have the following items.

1. Windows 7 original installation DVD
2. USB thumb drive with at least 4 GB capacity
3. Software utility to create ISO image from DVD, e.g.
 - ImgBurn (<http://www.imgburn.com>)
 - Nero (<http://www.nero.com>)
4. Software utility to create bootable USB drive from ISO file, e.g.
 - Microsoft Windows USB/DVD Download Tool
(<https://www.microsoft.com/en-us/download/windows-usb-dvd-download-tool>)
 - ISO to USB (<http://www.isotousb.com>)

You should have at least 10 GB disk space on your local drive.

5.4 Create Windows 7 USB Installation Flash Drive and Patching xHCI Driver

Please refer to the following procedures to create an installation flash drive to aid in smooth installation of Windows 7.

5.4.1 Step1 – Create .ISO File from Windows 7 DVD

The first step is to create a .iso file from the Windows 7 DVD. Here we use ImgBurn (<http://www.imgburn.com>) to create the .iso file and save it to local drive.

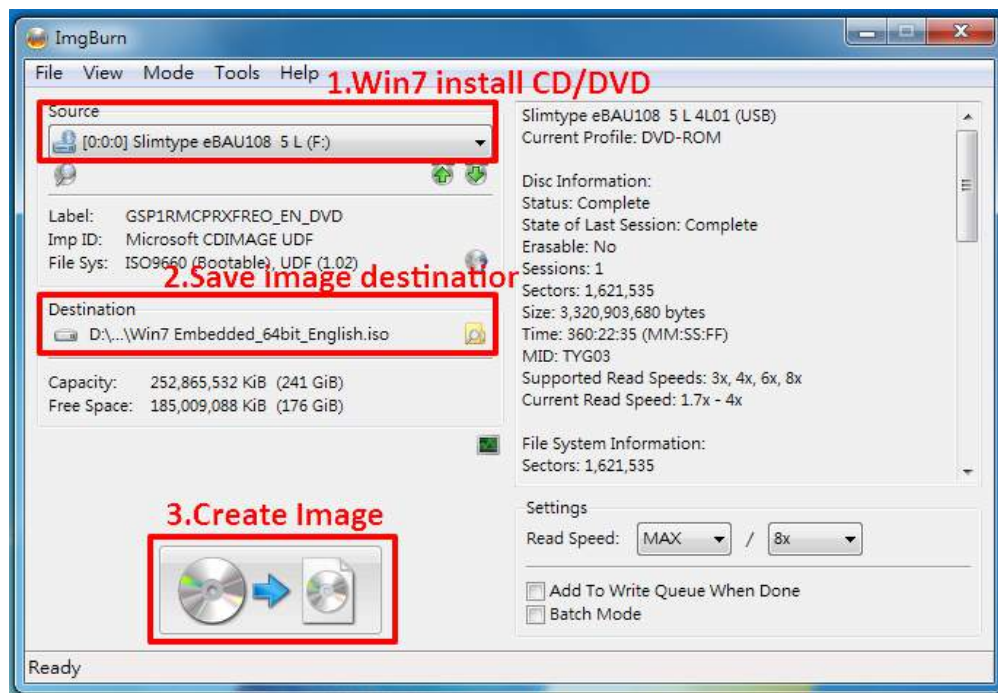

5.4.2 Step 2 – Create USB Flash Drive Installer from .ISO

The next step is to create a bootable USB flash drive using the .iso file created in step 1. Here we use Microsoft Windows USB/DVD Download Tool to create the USB flash drive

(<https://www.microsoft.com/en-us/download/windows-usb-dvd-download-tool>).

Please note that the content of USB flash drive will be destroyed.

1. Right-click on the **'Windows 7 USB DVD Download Tool'** and select **'Run as administrator'**.
2. Follow the instructions below to create the USB flash drive installer.

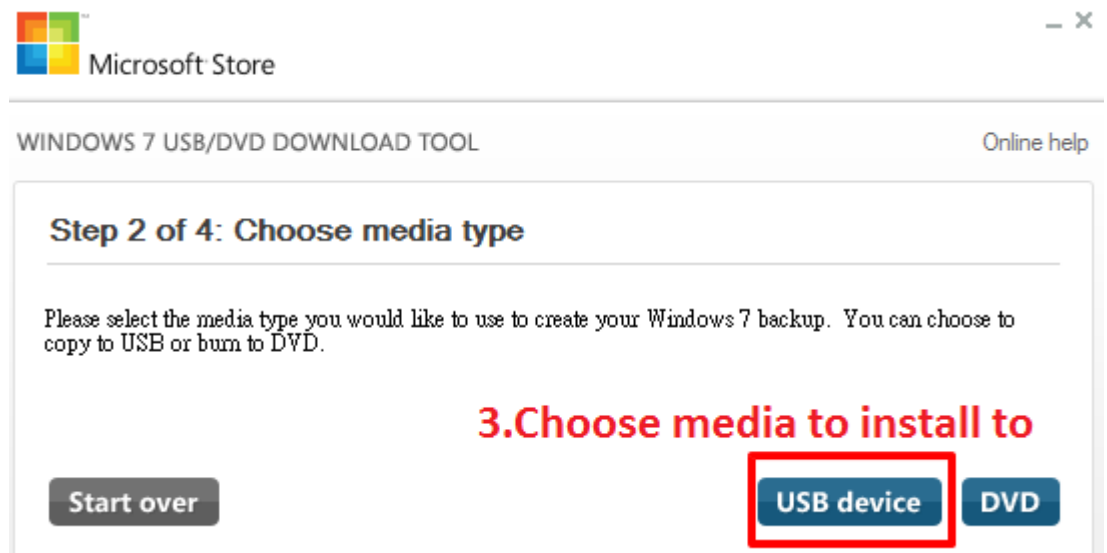
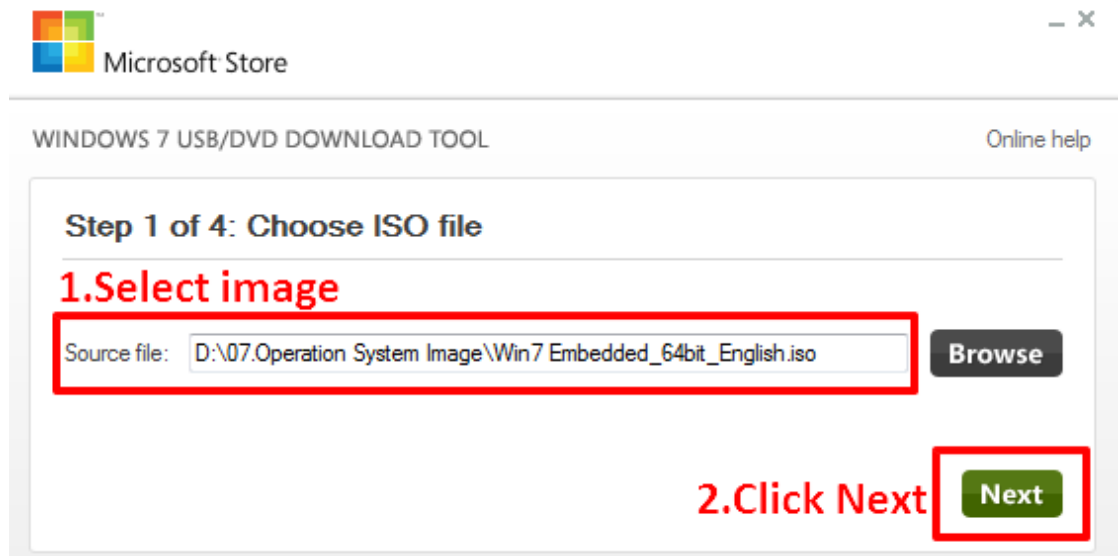



Microsoft Store

WINDOWS 7 USB/DVD DOWNLOAD TOOL Online help

Step 3 of 4: Insert USB device 

If your device is not displayed click "Refresh."

4. Select USB device

E:\ (Removable Disk) - 14.6 GB Free 

5. Click Begin copying

Begin copying

Start over

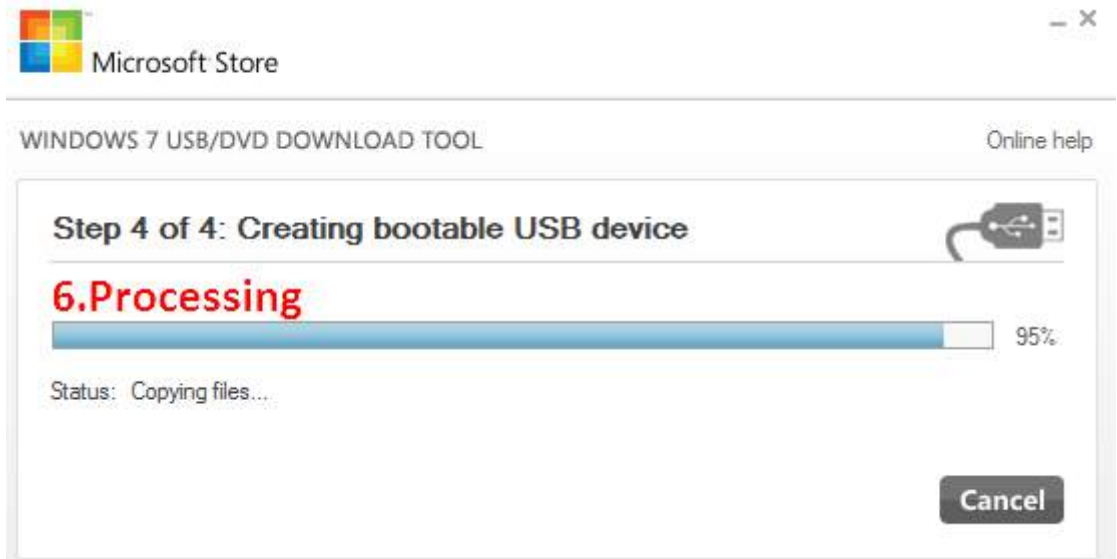

Microsoft Store

WINDOWS 7 USB/DVD DOWNLOAD TOOL Online help

Step 4 of 4: Creating bootable USB device 

6. Processing

 95%

Status: Copying files...

Cancel

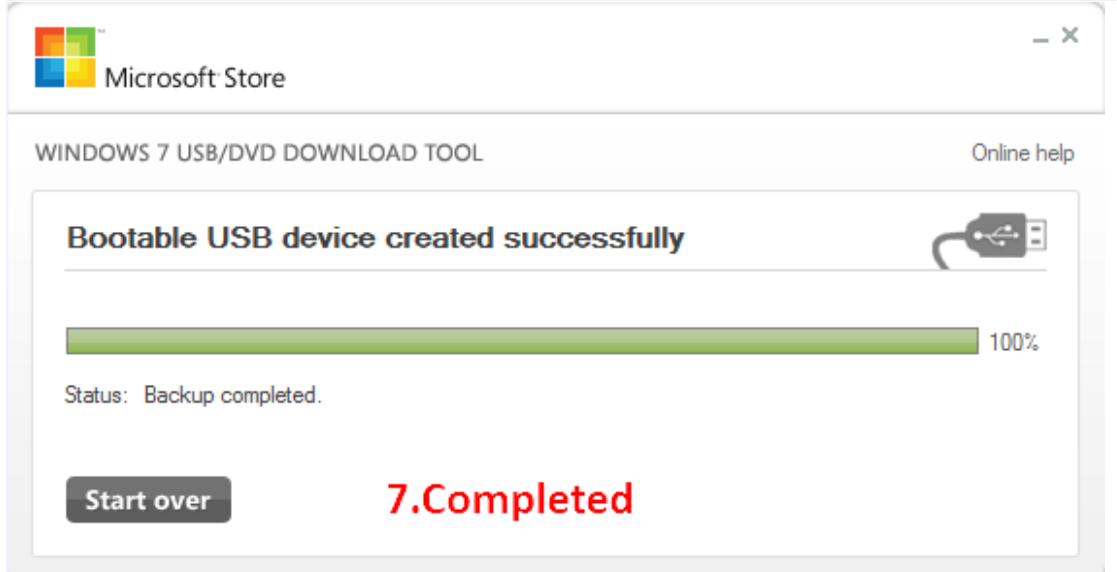

Microsoft Store

WINDOWS 7 USB/DVD DOWNLOAD TOOL Online help

Bootable USB device created successfully 

 100%

Status: Backup completed.

Start over

7. Completed

5.4.3 Step 3 – Create Folder and Copy Files for Patching Process

In this step, we need to create a working folder on your local drive and copy necessary files to it. Please follow the steps below.

1. Create a temporary working folder on your local drive. Here we use D:\WIM as an example.
2. Create another folder under D:\WIM for Intel xHCI driver files. Here we use \x86 for Win7 32-bit and \x64 for Win7 64-bit.
3. Copy xHCI driver files to the corresponding folder. You can find the driver files from Neousys Driver DVD.
 - For Win7 32-bit, copy all files from x:\Driver_Pool\USB3_10_Series\Win7_ALL\x86 to D:\WIM\x86
 - For Win7 64-bit, copy all files from x:\Driver_Pool\USB3_10_Series\Win7_ALL\x64 to D:\WIM\x64

(where x: denotes the drive of your DVD drive)

4. Copy **install.wim** and **boot.wim** from \sources folder of your USB flash drive to D:\WIM.

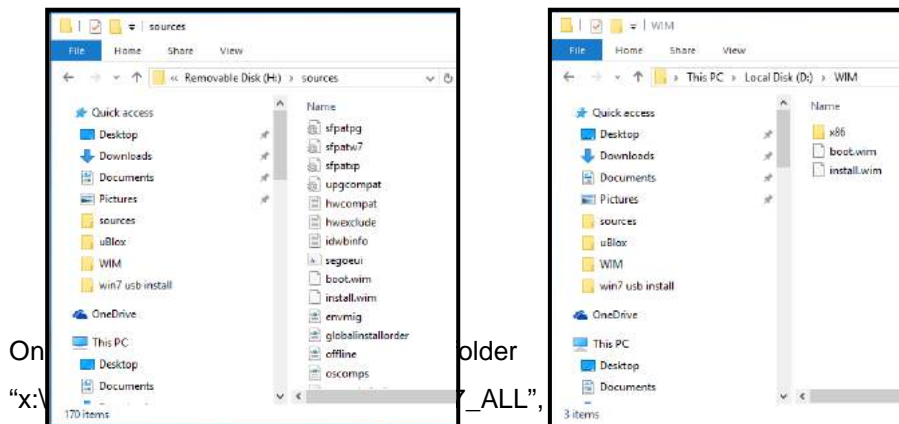

On the left screenshot, the path is "x:\Driver_Pool\USB3_10_Series\Win7_ALL",

(Win7_USB3_Patch_x86.bat or Win7_USB3_Patch_x64.bat) to the working folder D:\WIM.

5.4.4 Step 4 – Execute .bat File to Patch .wim Files

To support xHCI for Windows 7 installation, both install.wim and boot.wim need to be patched to include xHCI driver files. Neosys offers Windows-based batch files

(**Win7_USB3_Patch_x86.bat** for Windows 7 32-bit and

Win7_USB3_Patch_x64.bat for Windows 7 64-bit) to simplify this process.

1. Before executing the batch file, please make sure folders specified in the batch file are identical to your working folders.

```
SET IMAGE_PATH=D:\WIM
```

```
SET DRIVER_PATH=D:\WIM\x86
```

```
SET DRIVER_PATH=D:\WIM\x64
```

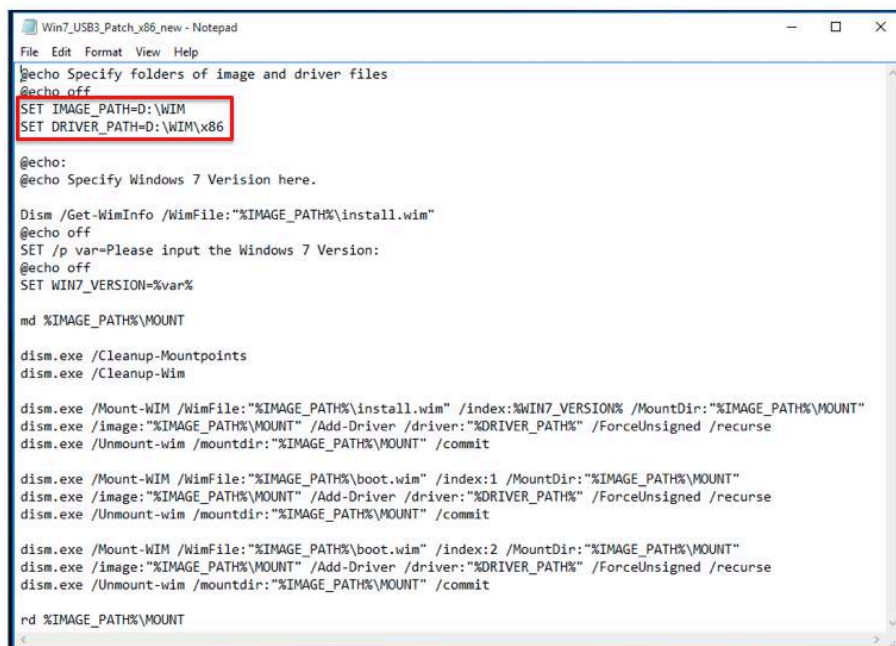

```
Win7_USB3_Patch_x86_new - Notepad
File Edit Format View Help
@echo Specify folders of image and driver files
@echo off
SET IMAGE_PATH=D:\WIM
SET DRIVER_PATH=D:\WIM\x86

@echo:
@echo Specify Windows 7 Version here.

Dism /Get-WimInfo /WimFile:"%IMAGE_PATH%\install.wim"
@echo off
SET /p var=Please input the Windows 7 Version:
@echo off
SET WIN7_VERSION=%var%

md %IMAGE_PATH%\MOUNT

dism.exe /Cleanup-Mountpoints
dism.exe /Cleanup-Wim

dism.exe /Mount-WIM /WimFile:"%IMAGE_PATH%\install.wim" /index:WIN7_VERSION% /MountDir:"%IMAGE_PATH%\MOUNT"
dism.exe /image:"%IMAGE_PATH%\MOUNT" /Add-Driver /driver:"%DRIVER_PATH%" /ForceUnsigned /recurse
dism.exe /Unmount-wim /mountdir:"%IMAGE_PATH%\MOUNT" /commit

dism.exe /Mount-WIM /WimFile:"%IMAGE_PATH%\boot.wim" /index:1 /MountDir:"%IMAGE_PATH%\MOUNT"
dism.exe /image:"%IMAGE_PATH%\MOUNT" /Add-Driver /driver:"%DRIVER_PATH%" /ForceUnsigned /recurse
dism.exe /Unmount-wim /mountdir:"%IMAGE_PATH%\MOUNT" /commit

dism.exe /Mount-WIM /WimFile:"%IMAGE_PATH%\boot.wim" /index:2 /MountDir:"%IMAGE_PATH%\MOUNT"
dism.exe /image:"%IMAGE_PATH%\MOUNT" /Add-Driver /driver:"%DRIVER_PATH%" /ForceUnsigned /recurse
dism.exe /Unmount-wim /mountdir:"%IMAGE_PATH%\MOUNT" /commit

rd %IMAGE_PATH%\MOUNT
```

- Right click on the batch file, select “Run as administrator” and click on “Yes” to continue. A menu of various Windows 7 version options will appear, please enter the corresponding index number for your Windows 7 version and press Enter.

```

C:\Windows\System32\cmd.exe
Specify folders of image and driver files
Specify Windows 7 Verision here.
Deployment Image Servicing and Management tool
Version: 10.0.10240.16384
Details for image : D:\WIM\install.wim
Index : 1
Name : Windows 7 STARTER
Description : Windows 7 STARTER
Size : 8,067,003,725 bytes
Index : 2
Name : Windows 7 HOMEBASIC
Description : Windows 7 HOMEBASIC
Size : 8,127,590,116 bytes
Index : 3
Name : Windows 7 HOMEPREMIUM
Description : Windows 7 HOMEPREMIUM
Size : 8,569,006,173 bytes
Index : 4
Name : Windows 7 PROFESSIONAL
Description : Windows 7 PROFESSIONAL
Size : 8,442,573,362 bytes
Index : 5
Name : Windows 7 ULTIMATE
Description : Windows 7 ULTIMATE
Size : 8,610,128,720 bytes
The operation completed successfully
Please input the Windows 7 Version: 

```

- This will automatically patch both install.wim and boot.wim to include xHCI drivers. The patch process may take a few minutes to complete.
- Once the patch process has finished, please copy the patched “install.wim” and “boot.wim” files from your local drive to the USB flash drives’ \sources folder. A prompt may appear asking if you want to overwrite existing files, please click “Yes” and continue.

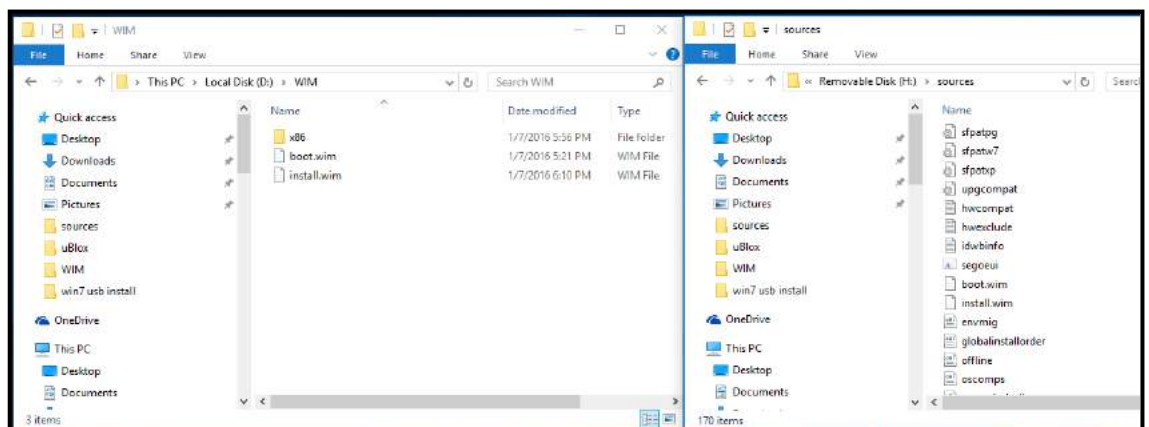

5.4.5 Step 5 – Install Windows 7 Using USB Flash Drive Installer

Now you can use the USB flash drive to install Windows 7 on your system.

1. Plug the USB flash drive to USB port.
2. Power on the system and press F12 to select USB flash drive as boot device.
3. Follow regular installation process to install Windows 7 on your system. The xHCI driver is included in the newly-installed system.



NOTE

If the following warning message appears “Setup was unable to create a new system partition or locate an existing system partition”, please unplug and re-plug the USB flash drive, click ‘Refresh’ and try again.

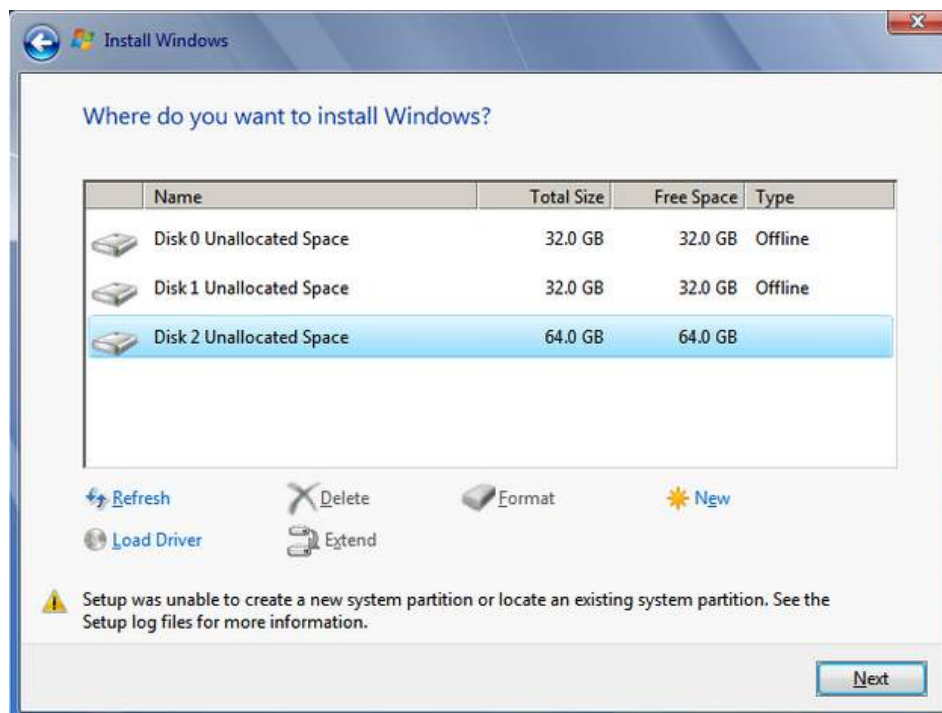

5.5 Install Drivers Automatically

The system comes with a “Drivers & Utilities” DVD that offers “one-click” driver installation process. It automatically detects your Windows operating system and installs all necessary drivers for you system with a single click.

To install drivers automatically, please refer to the following procedures.

1. Insert the “Drivers & Utilities” DVD into a USB DVD-drive connect to your system. A setup utility launches and the following dialog appears.



Click on “**Automatic Driver Installation**” and the setup utility will automatically detect your Windows operating system and install all necessary drivers. The installation process takes about 6~8 minutes depending on your Windows version. Once driver installation is done, the setup utility reboots your Windows and you may begin using your system.

5.6 Install Drivers Manually

You can also manually install each driver for the system. Please note when installing drivers manually, you need to install the drivers in the following sequence mentioned below.

5.6.1 Windows 7 (x86)

The recommended driver installation sequence is

1. Chipset driver (x:\Driver_Pool\Chipset_10_Series\Win_ALL\SetupChipset.exe)
2. Graphics driver (x:\Driver_Pool\Graphics_6th_i7\Win_7_32\Setup.exe)
3. Audio driver (x:\Driver_Pool\Audio_ALC262\Win_ALL_32\Setup.exe)
4. LAN driver
(x:\Driver_Pool\GbE_I210_I350\Win_ALL_32\APPS\PROSETDX\Win32\DxSetup.exe)
5. ME driver (x:\Driver_Pool\ME_10_Series\Win_ALL_AMT\SetupME.exe)

5.6.2 Windows 7 (x64)

The recommended driver installation sequence is

1. Chipset driver (x:\Driver_Pool\Chipset_10_Series\Win_ALL\SetupChipset.exe)
2. Graphics driver (x:\Driver_Pool\Graphics_6th_i7\Win_7_8_10_64\Setup.exe)
3. Audio driver (x:\Driver_Pool\Audio_ALC262\Win_ALL_64\Setup.exe)
4. LAN driver
(x:\Driver_Pool\GbE_I210_I350\Win_ALL_64\APPS\PROSETDX\Winx64\DxSetup.exe)
5. ME driver (x:\Driver_Pool\ME_10_Series\Win_ALL_AMT\SetupME.exe)

5.6.3 Windows 8/ 8.1/ 10 (x64)

The recommended driver installation sequence is

1. Chipset driver (x:\Driver_Pool\Chipset_10_Series\Win_ALL\SetupChipset.exe)
2. Graphics driver (x:\Driver_Pool\Graphics_6th_i7\Win_7_8_10_64\Setup.exe)
3. Audio driver (x:\Driver_Pool\Audio_ALC262\Win_ALL_64\Setup.exe)
4. LAN driver
(x:\Driver_Pool\GbE_I210_I350\Win_ALL_64\APPS\PROSETDX\Winx64\DxSetup.exe)
5. ME driver (x:\Driver_Pool\ME_10_Series\Win_ALL_AMT\SetupME.exe)

5.7 Driver Installation for Watchdog Timer Control

Neosys provides a driver package which contain function APIs for Watchdog Timer control function. You should install the driver package (WDT_DIO_Setup.exe) in prior to use these functions. Please note that you must install WDT_DIO_Setup_v2.2.7 or later versions.

5.7.1 Windows 7 (x86)

Please execute the driver setup program in the following directory.

x:\Driver_Pool\WDT_DIO\XP_Win7_8_32\WDT_DIO_Setup_v2.2.7.exe

5.7.2 Windows 7/ 8/ 10 (x64)

Please execute the driver setup program in the following directory.

x:\Driver_Pool\WDT_DIO\Win7_8_64\WDT_DIO_Setup_v2.2.7(x64).exe

5.7.3 Windows 7/ 8/ 10 (WOW64)

Please execute the driver setup program in the following directory.

x:\Driver_Pool\WDT_DIO\Win7_8_WOW64\WDT_DIO_Setup_v2.2.7(wow64).exe

Appendix A Using WDT & DIO

Watchdog Timer

The watchdog timer (WDT) function ensures reliable system operation. The WDT is a hardware mechanism to reset the system if the watchdog timer expires. Users can start the WDT and keep resetting the timer to make sure the system or program is running. Otherwise, the system shall be reset.

In this section, we'll illustrate how to use the function library provided by Neosys to program the WDT functions. Currently, WDT driver library supports Windows 7/ 8.1/ 10 32-bit and 64-bit versions. For other OS support, please contact Neosys Technology for further information.

Isolated DIO (Nuvo-5501-DIO Only)

The system also features isolated digital I/O is available for extended range of applications. Nuvo-5501-DIO features 8x DI channels and 8x DO channels via a DSub-25 connector. The digital I/O supports standard polling mode I/O access so users' program can read or write DIO channel(s) using the function library.

WDT and DIO Library Installation

Installing WDT_DIO Library

The WDT_DIO function library is delivered in the form of a setup package named **WDT_DIO_Setup.exe**. Prior to programming WDT, you should execute the setup program and install the WDT library. Please use the following WDT_DIO_Setup packages according to your operating systems and application.

- For Windows 7/ 8.1/ 10 32-bit OS, please install WDT_DIO_Setup_v2.2.7.exe or later version.
- For Windows 7/ 8.1/ 10 64-bit OS with 64-bit application (x64 mode), please install WDT_DIO_Setup_v2.2.7(x64).exe or later version.
- For Windows 7/ 8.1/ 10 64-bit OS with 32-bit application (WOW64 mode), please install WDT_DIO_Setup_v2.2.7(wow64).exe or later version..

To setup WDT & DIO Library, please follow instructions below.

1. Execute **WDT_DIO_Setup.2.2.7.exe**. and the following dialog appears.

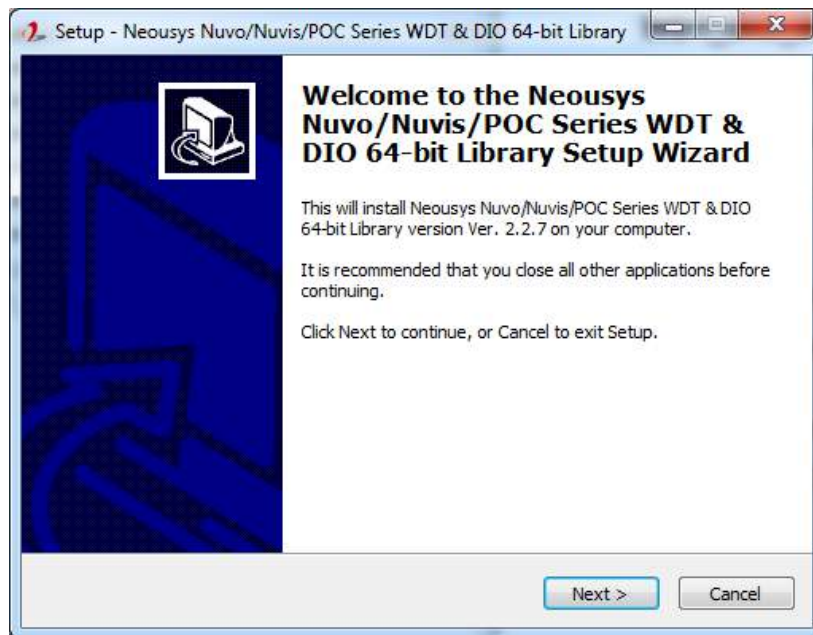

2. Click "Next >" and specify the directory of installing related files. The default directory is *C:\Neosys\WDT_DIO*.

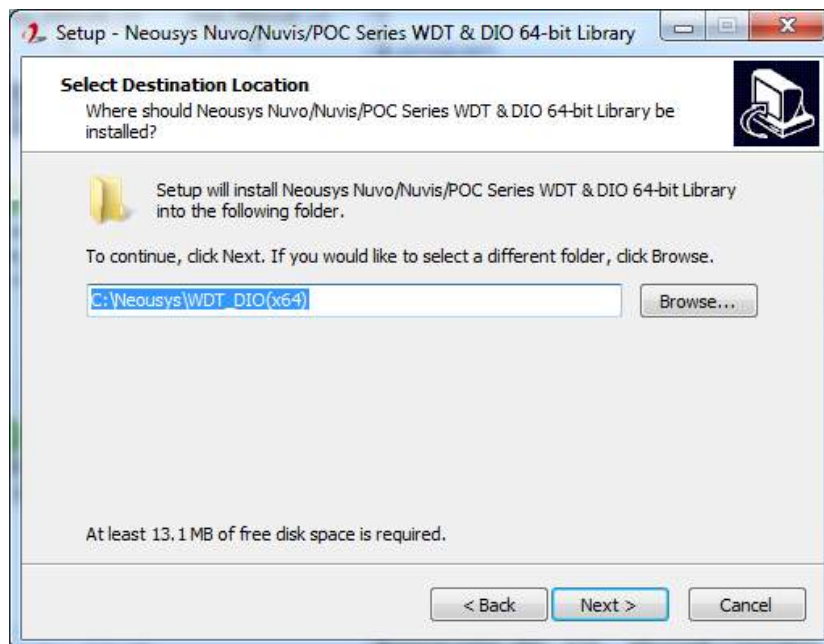

- Once the installation has finished, a dialog will appear to prompt you to reboot the system. The WDT & DIO library will take effect after the system has rebooted.

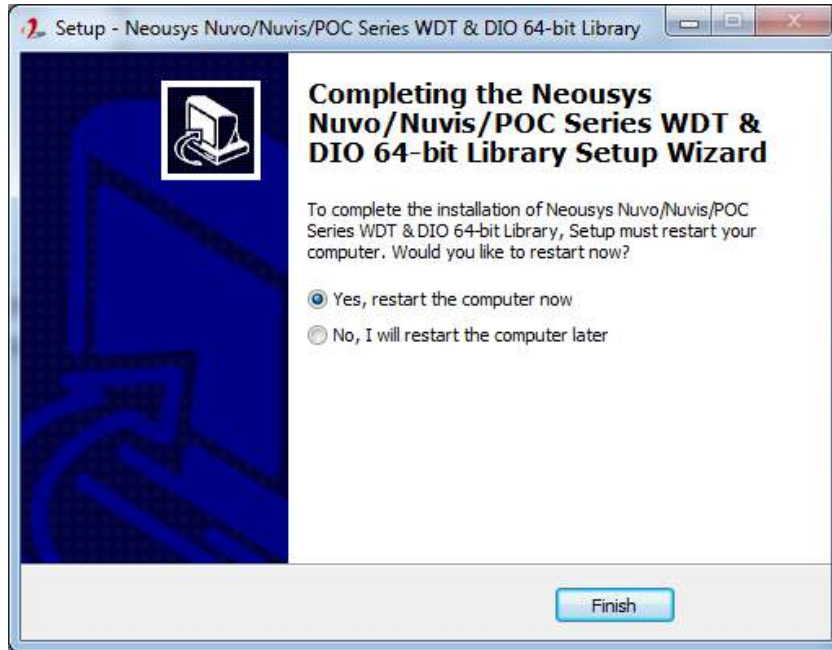

- When programming your WDT or DIO program, the related files are located in

Header File:	\Include
Library File:	\Lib
Function	\Manual
Reference:	
Sample Code:	\Sample\ WDT_Demo (Demo for Watchdog Timer) \Sample\ DIO_Demo (Demo for Polling I/O)

WDT Functions

InitWDT

Syntax	BOOL InitWDT(void);
Description:	Initialize the WDT function. You should always invoke InitWDT() before set or start watchdog timer.
Parameter	None
Return Value	TRUE: Successfully initialized FALSE: Failed to initialize
Usage	BOOL bRet = InitWDT();

SetWDT

Syntax	BOOL SetWDT(WORD tick, BYTE unit);
Description	Set timeout value and unit for watchdog timer. When InitWDT() is invoked, a default timeout value of 255 seconds is assigned.
Parameter	tick WORD value (1 ~ 65535) to indicate timeout ticks. unit BYTE value (0 or 1) to indicate unit of timeout ticks. 0 : unit is minute 1 : unit is second
Return Value	If value of unit is correct (0 or 1), this function returns TRUE, otherwise FALSE.
Usage	WORD tick=255; BYTE unit=1; //unit is second. BOOL bRet = SetWDT(tick, unit); //timeout value is 255 seconds

StartWDT

Syntax	BOOL StartWDT(void);
Description	Starts WDT countdown. Once started, the WDT LED indicator will begin blinking. If ResetWDT() or StopWDT is not invoked before WDT countdowns to 0, the WDT expires and the system resets.
Parameter	None
Return Value	If the timeout value is given in correct format (WDT started), this function returns TRUE, otherwise FALSE
Usage	BOOL bRet = StartWDT()

ResetWDT

Syntax	BOOL ResetWDT(void);
Description	Reset the timeout value to the value given by SetWDT().If ResetWDT() or StopWDT is not invoked before WDT countdowns to 0, the WDT expires and the system resets.
Parameter	None
Return Value	Always returns TRUE
Usage	BOOL bRet = ResetWDT()

StopWDT

Syntax	BOOL StopWDT(void);
Description	Stops the countdown of WDT. When WDT has stopped, the WDT LED indicator stops blinking.
Parameter	None
Return Value	Always returns TRUE
Usage	BOOL bRet = StopWDT()

DIO Functions

InitDIO

Syntax	BOOL InitDIO(void);
Description	Initialize the DIO function. You should always invoke InitDIO() before write/read any DIO port/channel.
Parameter	None
Return Value	Returns TRUE if initialization successes, FALSE if initialization failed.
Usage	BOOL bRet = InitWDT()

DIReadLine

Syntax	BOOL DIReadLine(BYTE ch);
Description	Read a single channel of isolated digital input.
Parameter	ch BYTE value specifies the DI channel to be read. <i>Ch</i> should be a value of 0 ~ 7.
Return Value	The status (TRUE or FALSE) of the specified DI channel.
Usage	BYTE ch=3; //DI channel #3 BOOL DIChValue = DIReadLine(ch); //read DI channel #3

DIReadPort

Syntax	WORD DIReadPort(void);
Description	Read the entire isolated digital input port (8 channels).
Parameter	None
Return Value	A WORD value (0~255) indicates the status of DI port (8 DI channels).
Usage	WORD DIPortValue = DIReadPort ();

DOWriteLine

Syntax	void DOWriteLine(BYTE ch, BOOL value);
Description	Write a single channel of isolated digital output.
Parameter	<p>ch BYTE value specifies the DO channel to be written. <i>Ch</i> should be a value of 0 ~ 7.</p> <p>value BOOL value (TRUE or FALSE) specifies the status of DO channel.</p>
Return Value	None
Usage	<pre> BYTE ch=3; //DI channel #3 BOOL DOChValue=TRUE; DOWriteLine(ch, DOChValue); //write DO channel #3 as TRUE </pre>

DOWritePort

Syntax	void DOWritePort(WORD value);
Description	Write the entire isolated digital output port (8 channels).
Parameter	<p>value WORD value specifies the status of the DO port. <i>Value</i> should be a value of 0~255.</p>
Return Value	None
Usage	<pre> WORD DOPortValue=0XFF; //11111111b DOWritePort(DOPortValue); //write DO port as 11111111b </pre>